



CATALOGUE | CATÁLOGO | CATALOG

2026





La contaminación de nuestros ríos, mares y océanos por plásticos es una de las mayores problemáticas a nivel mundial. El agua es nuestro medio de vida y es por eso que todos debemos contribuir a evitar esta contaminación.

Desde Abrisa creemos que las empresas también debemos dar un paso al frente en este conflicto que afecta a todos. Es por este motivo por lo que, la nueva gama de accesorios hidráulicos se presentará en formato de caja de cartón. Desde un punto de vista de volumen, costes y logístico no sería necesario este cambio, pero creemos necesario este comienzo en la lucha contra esta causa.



Envases con colgador
Packing with a hanger
Emballages avec cintre

El código QR le dará acceso a nuestros certificados

The QR code will give you access to our certificates

Avec le code QR vous aurez accès à nos certificats



Código de barras en las bolsas
Code bar in the bags
Codes-barres au des sacs



Medidas técnicas
Technical measures
Mesures techniques

Dimensión A-B-C
127 x 87 x 170
117 x 78 x 163
140 x 87 x 218
153 x 87 x 223
227 x 135 x 290



4 idiomas
4 languages
4 langues

Código de barras
Code bar
Codes-barres

Medidas técnicas
Las medidas técnicas (mm) se deben utilizar de modo orientativo
A. (Largo): la medida más larga del eje horizontal
B. (ancho): La medida más corta del eje horizontal
C. (alto): La medida del eje vertical
A max (Largo máximo): la medida más larga del eje horizontal máxima.
C max (Alto máximo): La medida del eje vertical máxima

Technical measures
Use these measure properly because there are guiding measure (mm)
A. (Large): The largest measure of the horizontal axis.
B. (wide): The shortest measure of the horizontal axis
C. (high): The vertical axis measure
A max (the largest): The largest of the horizontal axis
C max (The highest): The highest of the vertical axis.



Pág.	ESPAÑOL	INGLÉS	FRANCÉS	PORTUGUÉS
4	FILTRADO	FILTRATION	FILTRATION	FILTRO
8	ACCESORIOS PARA BIDONES Y CONVERSORES	TANK ACCESSORIES AND CONVERTERS	ACCESOIRES POUR CUVES ET CONVERSEURS	ACESSORIOS PARA BIDOES E CONVERSEORES
10	HERRAMIENTAS	TOOLS	OUTILS	FERRAMENTAS
12	ABONADO	FERTILIZATION	FERTILISATION	ABONADO
13	ARQUETAS	VALVE BOX	REGARD	CAIXA DE JARDIM
16	ELECTROVÁLVULAS	ELECTRIC VALVES	ELECTROVALVES	ELECTROVALVULAS
17	COLECTORES PARA ELECTROVÁLVULAS	THREADED CONNECTORS FOR ELECTRIC VALVES	COLLECTEURS POUR ELECTROVANNES	COLECTORES PARA ELECTROVALVULAS
18	CONEXIONES HIDRAÚLICAS	HYDRAULIC CONNECTIONS	RACCORDS HYDRAULIC	CONEXOES HYDRAULIC
20	ASPERSIÓN	ASPERSION	ASPERSION	ASPERSAO
21	JARDINERÍA	GARDENING	JARDINAGE	JARDINAGEM
22	MICROASPERSIÓN	MICROSPRINKLER	MICROASPERSION	MICROASPERSAO
26	ACCESORIOS Y ESTACAS	ACCESSORIES AND STAKES	ACCESOIRES ET ENJEUX	ACESSORIOS E PILHAS
27	VENTOSAS	AIR RELEASE VALVE	SOUPAPE DE DETENTE	VENTOSA
29	UNIÓN MICROTUBO ACETAL	MICROTUBE CONNECTOR ACETAL	RACCORD MICROTUBE ACETAL	UNIAO MICROTUBO ACETAL
30	UNIÓN SIMPLE	SIMPLE UNION	RACCORD SIMPLE	UNIAO SIMPLES
32	UNIÓN 4 PUNTAS	4 POINTED START UNION	RACCORD AVEC 4 POINTES	UNIAO 4 PONTAS ACETAL
33	ACOPLES	CONNECT	RACCORDER	ACOPLE
34	UNIÓN ACETAL	ACETAL UNION	RACCORD EN ACETAL	UNIAO ACETAL
39	JUNTAS Y GOMAS	JOINTS	JOINTS	JOINTS
40	UNIÓN SEGURIDAD	SAFETY UNION	RACCORD DE SECURITÉ	UNIAO SEGURANÇA
44	UNIÓN COMPRESIÓN	COMPRESSION UNION	RACCORD PAR COMPRESSION	UNIAO DE COMPRESSAO
45	UNIÓN CINTA PPC	TAPE UNION	RACCORD TUYAU PLAT SUPER-FILETÉ	UNIAO FITA SUPERROSCADA
47	UNIÓN "Y" ACETAL	"Y" ACETAL UNION	RACCORD "Y" POUR TUYAU PLAT EN ACETAL	UNIAO DE FITA "Y" ACETAL
48	UNIÓN CINTA EXTRA	EXTRA TAPE UNION	RACCORD TUYAU	UNIAO FITA
50	UNIÓN CINTA	TAPE UNION	RACCORD POUR TUYAU	UNIAO FITA ROSCADA
51	UNIÓN CINTA MEGAROSCADA	MEGA-THREADED TAPE UNION	RACCORD POUR TUYAU PLAT MEGA-FILETÉ	UNIAO FITA MEGA-ROSCADA
52	UNIÓN LAYFLAT	LAYFLAT UNION	RACCORD LAYFLAT	UNIAO LAYFLAT
56	LLAVES TOTAL	TOTAL VALVES	VANNES TOTALE	VALVULA TOTAL
59	LLAVES CLIPADAS	PRESSED VALVES	VANNES PRESSEES	VALVULAS PRESIONADAS
61	LLAVES EXTRA	EXTRA VALVES	VANNES EXTRA	VALVULAS EXTRA
64	TAPONES	PLUGS	BOUCHONS	TACOS
66	GOTEROS	DRIPPERS	GOUTTEURS	GOTEJADORS
69	ACCESORIOS PARA HIDROPÓNICO	HYDROPHONICS ACCESSORIES	ACCESOIRES POUR HYDROPONIQUE	ACESSORIOS HIDROPONIA
70	SUJECIONES	FASTENING DEVICES	FIXATIONS	FIXACOES
72	COLLARINES	SADDLE CLAMP	COLLIER DE PRISE	TOMADA DE CARGA
74	UNIÓN PVC	PVC UNION	RACCORD PVC	UNIAO PVC
75	VÁLVULAS PVC	PVC VALVES	VANNES PVC	VALVULAS PVC
76	UNIÓN FITTING PE	FITTING FOR PE	RACCORD COMPRESSION POUR PVC	ACESSORIOS FITTING PE
82	ROSCADOS	THREADED	FILETÉS	ACESSORIOS ROSCADOS
86	SUMIDEROS Y CALDERETAS	DRAIN FLOORES	SIPHONS	SUMIDOUROS E CAIXAS SIFONICAS
88	ACCESORIOS DESAGÜE	DRAIN ACCESSORIES	ACCESOIRES D'EGOUT	ACESSORIOS DE SAIDA
92	SIFONES	SIPHONES	SIPHONS	SIFOES
93	SIFONES DOBLES	DOUBLE SIPHON	SIPHON DOUBLE	SIFOES DUPLOS
94	VÁLVULA DESAGÜE CON REBOSADERO	DRAIN VALVES WITH SINK WASTE OUTLET	VANNE D'EGOUT AVEC DEVERSOIR	VALVULAS BASE CHUVEIRO
95	COMPLEMENTOS	COMPLEMENTS	COMPLEMENTS	COMPLEMENTOS
96	REPUESTOS Y COMPLEMENTOS	REPLACEMENTS AND COMPLEMENTS	REPLACEMENTS ET COMPLEMENTS	ACESSORIOS DE REPOSICAO E COMPLEMENTOS





ACCESORIOS DE RIEGO IRRIGATION ACCESSOIRES



ACCESSOIRES POUR L'IRRIGATION
ACCESORIOS DE REGO

**FILTRO DE ANILLA
DISC FILTER
FILTRE A DISQUES
FILTRO DE ANILHA**

Ref.	Ø (" - MESH)			€	Dimensiones A-B-C
0210	2 - 120	-	2	215,8140	273x212x419
0211	2 Super - 120	-	1	315,8195	268x213x552
0212	3 - 120	-	1	315,8195	268x213x552
0220	2 - 140	-	2	215,8140	273x212x419
0221	2 Super - 140	-	1	315,8195	268x213x552
0222	3 - 140	-	1	315,8195	268x213x552

 DISPONIBLE
AVAILABLE **NPT**
**FILTRO DE ANILLA MEGA
MEGA DISC FILTER
FILTRE A DISQUES MEGA
FILTRO ANILHA MEGA**

Ref.	Ø (" - MESH)			€	Dimensiones A-B-C
0281	2 - 120	-	2	357,7610	
0282	3 - 120	-	2	357,7610	
0291	2 - 140	-	2	357,7610	
0292	3 - 140	-	2	357,7610	
0295	2 - 140 (NPT)	-	2	357,7610	
0297	3 - 140 (NPT)	-	2	357,7610	

*Los articulos NPT se fabricarán bajo pedido

**RECAMBIO FILTRO DE ANILLA
DISC CARTRIDGE
CARTOUCHE DU FILTRE A DISQUES
RECARGA FILTRO DE ANILHA**

Ref.	Ø (" - MESH)			€	Dimensiones A-B-C
0213	2 - 120	-	2	107,9134	151x151x324
0214	2 Super y 3 - 120	-	2	157,9097	151x151x468
0223	2 - 140	-	2	107,9134	151x151x324
0224	2 Super y 3 - 140	-	2	157,9097	151x151x468

**RECAMBIO FILTRO DE ANILLA MEGA
MEGA DISC CARTRIDGE
CARTOUCHE DU FILTRE A DISQUES MEGA
RECARGA FILTRO DE ANILHA MEGA**

Ref.	Ø (" - MESH)			€	Dimensiones A-B-C
0284	2 y 3 - 120	-	2	178,8806	493x136x136
0294	2 y 3 - 140	-	2	178,8806	493x136x136



Tuerca de polipropileno ajustada para montar y desmontar con facilidad. SIN INCOMODAS abrazaderas de metal.

Roscas de inyección. No torneado manual.

Adjusted polyethylene threaded connector for easy setting and removing.

Injection threaded connectors. No manually turned. WITH NO AWKWARD metal braces.

Salida desagüe para limpieza de filtro.
Drainage exit to clean the filter.



Sistema DOBLE ROSCA Permite limpiar las anillas sin desmontar el cartucho.

DOUBLE THREAD System which allows you to clean the rings without removing the cartridge.



Diseño especial para obtener mayor rendimiento de filtrado y RETENER mayor cantidad de suciedad con mínimo gasto energético.

Special design to obtain better filtering performance and retain more dirty with minimal energy waste.



Llave apretar fitting de utilidad en filtros de herramientas.

Ejemplo Ver apartado de herramientas.

Torque wrench to tightening fitting Filters utility example See tools section.



Equipado con 2 juntas toricas para mayor estanqueidad de la suciedad en su malla de acero INOX. Maxima estanqueidad reforzado con junta torica encajada en el tapon de cierre.

Equipped with 2 O-Rings to keep more dirty in the INOX steel screen. Highest stagnancy, reinforced with a fixed O-Ring on the screw top.



Pérdida de carga filtro de anilla de 140 Mesh de 2". Ref: 2163

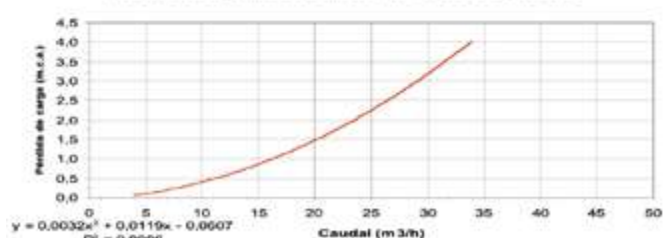

Pérdida de carga filtro de anilla de 140 Mesh de 3". Ref: 2190

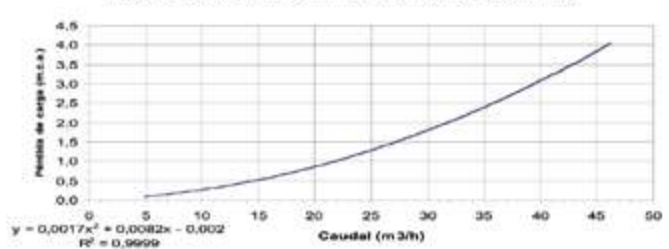

**FILTRO DE ANILLA EN LÍNEA 120 MESH
DISC FILTER 120 MESH**

Ref.	Ø (")			€	Dimensiones A-B-C
A 0273	1/2	-	20	14,7000	127x87x170
A 0275	3/4	-	20	16,8000	117x78x163
0262	1	-	20	19,8600	140x87x218
A 0263	1 1/4	-	20	26,7540	153x87x223
0264	1 1/2	-	10	41,8950	227x135x290
0265	2	-	10	54,2245	235x134x343

**FILTRE A DISQUES 120 MESH
FILTRO DE ANILHA LIMHA 120 MESH**

Ref.	Ø (")			€	Dimensiones A-B-C
A 0270	1 (NPT)	-	20	19,8600	140x87x218
0269	1 1/2 (NPT)	-	10	41,8950	153x87x223
0268	2 (NPT)	-	10	51,6424	227x135x290

*Los articulos NPT se fabricarán bajo pedido, USA.

**FILTRO INTERLÍNEA
IN LINE FILTER
FILTRE CANNELÉ
FILTRO INTERLINHA**

Ref.	Ø (")			€	Dimensiones A-B-C
0271	16 mm	-	50	4,6084	120x27x27
0272	20 mm	-	50	4,6084	120x27x27
0274	16 mm	-	50	4,6084	115x27x27
0276	1/2"	-	50	4,6084	120x27x27

**RECAMBIO FILTRO ANILLA EN LÍNEA 120 MESH
DISC CARTRIDGE 120 MESH
CARTOUCHE FILTRE A DISQUES 120 MESH
RECARGA FILTRO ANILHA 120 MESH**

Ref.	Ø (")			€	Dimensiones A-B-C
0266	1	-	20	9,9299	178x50x50
0261	1 1/2	-	10	27,1122	185x83x83
0267	2	-	10	27,1122	230x83x83



**FILTRO MALLA (50 MESH)
SCREEN FILTER (50 MESH)
FILTRE A TAMIS (50 MESH)
FILTRO DE MALHA (50 MESH)**

Ref.	Ø (")		€	Dimensiones A-B-C
0230	1/2	- 20	14,9975	127x87x170
0231	3/4	- 20	14,9975	117x78x163
0232	1	- 20	16,3735	140x87x218
0233	1 1/4	- 20	22,0284	153x87x223
0234	1 1/2	- 10	28,1513	227x135x290
0235	2	- 10	48,5700	235x134x343

**FILTRO MALLA (100 MESH)
SCREEN FILTER (100 MESH)
FILTRE A TAMIS (100 MESH)
FILTRO DE MALHA (100 MESH)**

Ref.	Ø (")		€	Dimensiones A-B-C
0240	1/2	- 20	14,9975	127x87x170
0241	3/4	- 20	14,9975	117x78x163
0242	1	- 20	16,3735	140x87x218
0243	1 1/4	- 20	22,0284	153x87x223
0244	1 1/2	- 10	28,1513	227x135x290
0245	2	- 10	48,5700	235x134x343

**FILTRO MALLA (120 MESH)
SCREEN FILTER (120 MESH)
FILTRE A TAMIS (120 MESH)
FILTRO DE MALHA (120 MESH)**

Ref.	Ø (")		€	Dimensiones A-B-C
0250	1/2	- 20	14,9975	127x87x170
0251	3/4	- 20	14,9975	117x78x163
0252	1	- 20	16,3735	140x87x218
0253	1 1/4	- 20	22,0284	153x87x223
0254	1 1/2	- 10	28,1513	227x135x290
0255	2	- 10	48,5700	235x134x343
A 0260	2 (NPT)	- 10	48,5700	235x134x343

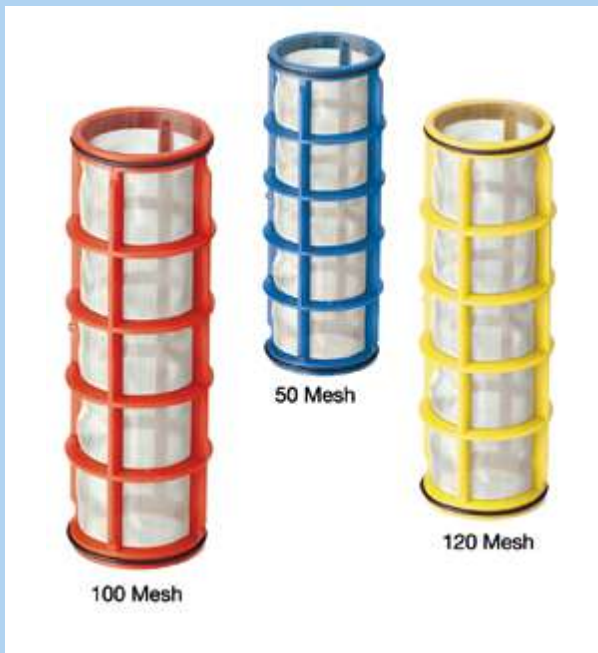

**RECAMBIO FILTRO MALLA (50 MESH)
SCREEN FILTER CARTRIDGE (50 MESH)
CARTOUCHE FILTRE A TAMIS (50 MESH)
RECARGA FILTRO MALHA (50 MESH)**

Ref.	Ø (")		€	Dimensiones A-B-C
0236	1/2 - 3/4	- 20	7,3748	52x52x126
0237	1 - 1 1/4	- 20	11,0211	52x52x166
0238	1 1/2	- 10	14,0757	85x85x179
0239	2	- 10	24,2850	85x85x228

**RECAMBIO FILTRO MALLA (100 MESH)
SCREEN FILTER CARTRIDGE (100 MESH)
CARTOUCHE FILTRE A TAMIS (100 MESH)
RECARGA FILTRO MALHA (100 MESH)**

Ref.	Ø (")		€	Dimensiones A-B-C
0246	1/2 - 3/4	- 20	7,3748	52x52x126
0247	1 - 1 1/4	- 20	11,0211	52x52x166
0248	1 1/2	- 10	14,0757	85x85x179
0249	2	- 10	24,2850	85x85x228

**RECAMBIO FILTRO MALLA (120 MESH)
SCREEN FILTER CARTRIDGE (120 MESH)
CARTOUCHE FILTRE A TAMIS (120 MESH)
RECARGA FILTRO MALHA (120 MESH)**

Ref.	Ø (")		€	Dimensiones A-B-C
0256	1/2 - 3/4	- 20	7,3748	52x52x126
0257	1 - 1 1/4	- 20	11,0211	52x52x166
0258	1 1/2	- 10	14,0757	85x85x179
0259	2	- 10	24,2850	85x85x228



*Los articulos NPT se fabricarán bajo pedido, USA.



ADAPTADOR UNIVERSAL BIDONES
UNIVERSAL TANK ADAPTER
ADAPTATEUR UNIVERSEL POUR CUVES
ADAPTADOR UNIV. CUVES

Ref.	Ø (")			€	Dimensiones A-B-C
0625	1 1/2	1	20	17,0270	61x76x76
0626	2	1	20	17,0270	61x76x76



ADAPTADOR UNIVERSAL BIDONES MACHO
UNIVERSAL TANK ADAPTER MALE
ADAPTATEUR UNIVERSEL POUR CUVES
ADAPTADOR MACHO UNIV. BIDAO

Ref.	Ø (")			€	Dimensiones A-B-C
0634	3/4	1	50	7,8198	53x69x69
0633	1	1	50	7,8198	53x69x69
0635	1 1/2	1	50	7,8198	53x69x69



CONVERTIDOR BSP-NPT
CONVERTER BSP-NPT
CONVERTISSEUR BSP-NPT
CONVERSOR BSP-NPT

Ref.	Ø (")			€	Dimensiones A-B-C
0646	2	-	100	9,0180	61x76x76
0647	2 1/2	-	20	24,7977	98x95x95
0648	3	-	10	26,2215	113x111x111



PASAMUROS SIMPLE
TANK CONNECTOR
TRAVERS-PAROI
PASSA-MUROS SIMPLE

Ref.	Ø (mm - ")			€	Dimensiones A-B-C
0611	20 - 1/2	1	100	3,7206	52x46x46
0612	25 - 3/4	1	100	3,8972	60x52x52
0613	32 - 1	1	100	5,4612	72x59x59
0614	40 - 1 1/4	1	50	8,1855	77x61x61
0615	50 - 1 1/2	1	40	10,8973	87x65x65
0616	63 - 2	1	30	13,9748	97x77x77



ADAPTADOR UNIVERSAL BIDONES MACHO - HEMBRA
UNIVERSAL TANK ADAPTER MALE - FEMALE
ADAPTATEUR UNIVERSEL POUR CUVES
ADAPTADOR MACHO-HEMBRA UNIV. BIDAO

ADAPTADOR BIDONES MACHO S.100 Y S.70 MACHO
TANK ADAPTER MALE S.100 AND S.70
ADAPTATEUR POUR CUVES S.100 ET S.70
ADAPTADOR MACHO BIDAO S.100 E S.70

Ref.	Ø (")			€	Dimensiones A-B-C
0632	1 - 3/4	1	50	9,0956	53x69x69
0631	1 1/2 - 1	1	50	9,8232	53x69x69
0600	Junta S. 60	-	-	7,5962	Estándar
0601	Junta S.100	-	-	8,8200	Estándar
0602	Junta S.70	-	-	8,8200	Estándar

Ref.	Ø (")			€	Dimensiones A-B-C
0636	S.100-1	1	25	17,8500	78X116X116
0637	S.100-2	1	25	17,8500	78X116X116
0638	S.70-1"	1	25	17,8500	78X116X116
0639	S.70-2"	1	25	17,8500	78X116X116





8 435277 905109



8 435277 905116



8 435277 905123



8 435277 905130



8 435277 905147



8 435277 905208



8 435277 905215



8 435277 905222



8 435277 905239



8 435277 905246



8 435277 905307



8 435277 905314



8 435277 905710



8 435277 905734



8 435277 906014



8 435277 906366



8 435277 906373

**SACA-BOCADO EXPULSOR SENCILLO
PUNCH WITH EJECTOR**
**EMPOTRE-PIECES SIMPLE AVEC EJECTEUR
PERFORADOR C/EXPULSAO SIMPLE**

Ref.	Ø (mm)			€	Dimensiones A-B-C
0510	2,6	-	50	7,4575	31x31x142
0511	3	-	50	7,4575	31x31x142
0512	4	-	50	7,4575	31x31x142
0513	7	-	50	7,4575	31x31x142
0514	9	-	50	7,4575	31x31x142

**SACA-BOCADO EXPULSOR PROFESIONAL
PROFESIONAL PUNCH WITH EJECTOR**
**EMPOTRE-PIECES PROFESSIONNEL AVEC EJECTEUR
PERFORADOR C/EXPULSAO PROF**

Ref.	Ø (mm)			€	Dimensiones A-B-C
0520	2,6	-	50	10,6771	31x31x142
0521	3	-	50	10,6771	31x31x142
0522	4	-	50	10,6771	31x31x142
0523	7	-	50	10,6771	31x31x142
0524	9	-	50	10,6771	31x31x142

**SACA-BOCADO CON ADAPTADORES
PUNCHER WITH ADAPTERS**
**EMPOTRE-PIECES AVEC ADAPTATEURS
PERFORADOR COM ADAPTADO**

Ref.	Ø (mm)			€	Dimensiones A-B-C
0571	3	1	50	14,5530	31x31x142
0573	7	1	50	14,5530	31x31x142

**PERFORADOR PISTOLA EXP. AUTOMÁTICO
PUNCH WITH AUTOMATIC EJECTOR**
**EMPOTRE-PIECES PISTOLET AUTO-EJECTEUR
ALICATE FURADOR**

Ref.	Ø (mm)			€	Dimensiones A-B-C
0530	3	1	10	35,3199	200x343x847
0531	4	1	10	35,3199	200x343x847



**LLAVE APRETAR FITTING
WRENCH FOR FASTENING FITTING**
CLE DE SERRAGE
CHAVE APERTO

**LLAVE APRETAR
WRENCH FOR FASTENING**
CLE DE SERRAGE
CHAVE APERTO

Ref.	Ø (")		€	Dimensiones A-B-C
0550	20 - 25 - 32	- 100	3,0648	235x12x67
0551	40 - 50 - 63	- 30	4,9946	279x14x67
0552	75 - 90 - 110	- 10	15,8667	494x15x161

Ref.	Ø (")		€	Dimensiones A-B-C
0560	20-25-32-40	- 100	2,7874	240x85x85
0561	50-63	- 30	4,5405	320x141x141
0540	Punzón y Gotero	- 500	0,8828	64x60x30



UTILIDADES DEL
PERFORADOR
PARA:

- Goteros
- Tomas
- Colarines

PUNCH
USE
FOR:

- Drippers
- Intakes
- Saddle





Caudalímetro: su graduación es perfecta y totalmente fiable. La bola indicadora de caudal es de acero inoxidable (AISI 304) para evitar oxidaciones por los fertilizantes.
Flowmeter: perfect and totally reliable pre-setting with a ball meter made of steel to prevent oxidation by the fertilizer (AISI 304).



Se sirve en un estuche con accesorios excepto manguera
 Available in a pack with the accessories.
 Tube not available

Llave dosificadora: sirve para aumentar o disminuir la dosis de fertilizante que queremos insertar en la instalación. También sirve de válvula antirretorno cuando la cerramos.
Adjustable valve: increases or decreases the fertilizer dose that we want to insert in the installation. Also, it works as a check valve when we close it.



Válvula de retención que evita que los fluidos vuelvan al depósito. Incorpora un filtro para evitar obstrucciones por los sedimentos en suspensión.
Return valve that prevents fluid back to the reservoir. It incorporates a filter to avoid obstructions by suspended sediments.



INYECTOR FERTILIZANTE FERTILIZER INJECTOR INJECTEUR D'ENGRAIS INJECTOR FERTILIZANTE

Ref.	Ø (") - Paso (mm)			€	Dimensiones A-B-C
0110	3/4 - 3	1	10	61,5471	156x40x143
0111	3/4 - 5	1	10	61,5471	156x40x143
0112	1 - 7	1	10	61,5471	156x40x143
0113	1 - 9	1	10	61,5471	156x40x143
0114	1 1/2 sin kit	1	6	75,0000	275x55x120
0115	2 sin kit	1	6	90,0000	295x60x150
0102	Valvula Retención	-	-	12,1275	
0101	Caudalímetro con bola Inox	-	-	9,9225	
0120	Abonadora L-10	-	-	131,2500	
0116	1 1/2 C/Kit	-	-	115,2113	275x55x120
0117	2 C/Kit	-	-	157,6575	295x60x150

*0114 y 0115 sin caudalímetro ni válvula de retención

*0114 y 0115 with out flowmeter and return valve

*0114 & 0115 sans débitmètre ni soupape antirretour

TABLA INYECTOR FERTILIZANTE

entrada Atm	salida Atm	pérdida carga	Inyector 3/4" Caudal absorción
0,9	0,2	0,7	2040 lh 20,4 lh
1,0	0,3	0,7	2160 lh 20,2 lh
1,0	0,1	0,9	2160 lh 42,8 lh
1,4	0,4	1,0	2520 lh 51,4 lh
1,6	0,8	0,8	2760 lh 14,0 lh
1,6	0,4	1,2	2760 lh 48,6 lh
1,9	1,0	0,9	3060 lh 26,0 lh
1,9	0,5	1,4	3120 lh 38,2 lh
2,4	0,4	2,0	2820 lh 31,0 lh
2,4	1,3	1,1	2820 lh 15,5 lh

entrada Atm	salida Atm	pérdida carga	Inyector 5mm 3/4" Caudal absorción
0,5	0,1	0,4	2280 lh 36 lh
0,8	0,3	0,5	2520 lh 38 lh
1,1	0,5	0,6	2940 lh 49 lh
1,5	0,8	0,7	3360 lh 78 lh
1,8	1,0	0,8	3780 lh 90 lh
2,0	1,2	0,8	4020 lh 100 lh
2,4	1,5	0,9	4380 lh 120 lh
2,7	1,6	1,1	4680 lh 125 lh
2,9	1,8	1,1	4860 lh 130 lh
3,1	2,0	1,1	4980 lh 150 lh

entrada Atm	salida Atm	pérdida carga	Inyector 7mm 1" Caudal absorción
0,6	0,2	0,4	1620 lh 33,9 lh
0,5	0,0	0,5	1800 lh 150 lh
0,9	0,5	0,4	1980 lh 54 lh
0,9	0,1	0,8	2160 lh 200 lh
1,3	0,8	0,5	2340 lh 78,2 lh
1,3	0,2	1,1	2460 lh 22,5 lh
1,7	1,1	0,6	2520 lh 120 lh
1,7	0,5	1,2	2760 lh 300 lh
2,0	1,5	0,5	2820 lh 40,9 lh
2,0	0,8	1,2	3120 lh 257 lh

entrada Atm	salida Atm	pérdida carga	Inyector 9mm 1" Caudal absorción
0,6	0,1	0,5	1860 lh 10,4 lh
1,7	0,3	0,8	2460 lh 85,7 lh
1,4	0,5	0,9	2760 lh 100 lh
1,6	0,8	0,8	3060 lh 128 lh
2,0	0,9	1,1	3360 lh 150 lh
2,3	1,1	1,2	3840 lh 225 lh
2,6	1,3	1,3	4080 lh 180 lh
2,8	1,5	1,3	4270 lh 200 lh
3,3	1,6	1,7	4500 lh 200 lh
3,5	1,6	1,9	4620 lh 225 lh
3,7	1,9	1,8	4740 lh 257 lh

Datos técnicos orientativos obtenidos en nuestros laboratorios por técnicos cualificados
 Technical orientative details obtained from our qualified technical laboratories
 Modelo registrado en la propiedad industrial / Patent rights of this model is registered



ARQUETA CIRCULAR CON CONEXIÓN
ROUND VALVE BOX WITH CONECTION
REGARD CYLINDRIQUE A RACCORDMENT
TAMPA CAIXA CONEXAO

ARQUETA CIRCULAR CON CONEXIÓN
ROUND VALVE BOX WITH CONECTION
REGARD CYLINDRIQUE A RACCORDMENT
TAMPA CAIXA CONEXAO

Ref.	Ø (")			€	Dimensiones A-B-C
0316	Llave - 3/4	-	16	12,1154	210x150

Ref.	Ø (")			€	Dimensiones A-B-C
0317	Valvula PVC macho	-	16	16,9664	210x150



ARQUETA CIRCULAR CON CONEXIÓN
ROUND VALVE BOX WITH CONECTION
REGARD CYLINDRIQUE A RACCORDMENT
TAMPA CAIXA CONEXAO

VÁLVULA HIDRANTE
CONEXION VALVE
CLAPETS
VALVULA HIDRANTE

Ref.	Ø (")			€	Dimensiones A-B-C
0318	Valvula Hidrante 3/4	-	16	19,3919	210x150

Ref.	Ø (")			€	Dimensiones A-B-C
2641	3/4	-	50	9,0956	
2642	1	-	50	9,8232	
2643	Llave 3/4	-	50	5,8212	





ARQUETA CIRCULAR
ROUND VALVE BOX
REGARD CYLINDRIQUE
TAMPA CAIXA REDONDA

ARQUETA CIRCULAR GRANDE
BIG ROUND VALVE BOX
GRAND REGARD CYLINDRIQUE
TAMPA CAIXA REDONDA GRANDE

Ref.	Ø (")		€	Dimensiones A-B-C
0310	-	- 30	6,9733	200x143
0319	-	- 24	8,3679	225x143

Ref.	Ø (")		€	Dimensiones A-B-C
0314	-	- 8	9,6049	9,1476

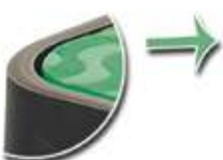

Fácil de empotrar ya que la tapadera se aloja en su interior
Easy to fit in because the lid is the interior



Incorpora un cierre anti-vandálico que impide la manipulación no deseada en su interior. Incluye una llave allen de plástico



Made of polyethylene of the highest endurance.

Fabricado en polipropileno de la más alta resistencia



Máxima superficie antideslizante con un diseño vanguardista
Highest Anti-Slipping surface with an avant-garde layout.

It includes an Anti-vandal closing system that stops anyone from a not desirable handling of the interior. A plastic Allen key is also included





ARQUETA PEQUEÑA
SMALL VALVE BOX
PETIT REGARD RECTANGULAIRE
CX ELECTROVALVULA

ARQUETA GRANDE
BIG VALVE BOX
GRAND REGARD
CX ELECTROVALVULA

Ref.	Ø (")		€	Dimensiones A-B-C
0311	-	- 15	11,6162	240x270x175

Ref.	Ø (")		€	Dimensiones A-B-C
0312	-	- 10	23,1820	420x320x200
0321	REFORZADA	- 10	33,6000	420x320x200



ARQUETA EXTRAGRANDE
KING VALVE BOX
EXTRAGRAND REGARD
TAMPA CAIXA EXTRAGRANDE

ARQUETA SÚPERGRANDE
JUMBO VALVE BOX
EXTRA GRAND REGARD
CX EVAVALVULA

Ref.	Ø (")		€	Dimensiones A-B-C
0315	-	- 6	29,3485	520x420x260
0322	REFORZADA	- 10	42,0000	520x420x260

Ref.	Ø (")		€	Dimensiones A-B-C
0313	-	- 5	63,2900	650x530x300
0323	REFORZADA	- 10	78,7500	650x530x300



ELECTROVÁLVULA 24V AC
ELECTRIC VALVE 24V. AC
ELECTROVANNE 24V. AC
ELECTROVÁLVULA 24V 1

ELECTROVÁLVULA 6-40V AC
ELECTRIC VALVE 6-40V. AC
ELECTROVANNE 6-40V. AC
ELECTROVÁLVULA 6-40V 1

Ref.	Ø (")			€	Dimensiones A-B-C
2511	1	-	15	39,2825	80x114x91x45
2512	1 C/Reg	-	15	43,8230	143x115x91x45
2513	1 1/2 C/Reg	-	10	74,0933	163x140x90x67
2514	2 C/Reg	-	2	134,6373	212x218x175x78
2515	3 C/Reg Macho	-	2	166,4175	220x205x168x88
2510	24v AC	-	-	21,1680	45x32x32

Ref.	Ø (")			€	Dimensiones A-B-C
2521	1	-	15	58,9264	
2522	1 C/Reg	-	15	65,7399	
2523	1 1/2 C/Reg	-	10	111,1320	
2524	2 C/Reg	-	2	201,9560	
2525	3 C/Reg	-	2	249,6236	
2520	6-40V DC	-	-	42,3360	

Este sistema rentabiliza la instalación porque hay más válvulas en menos espacio, no necesita ni cinta o hilo de sellado, ni estopa y reduce las horas de trabajo de las instalaciones

This system helps to improve the installation because there are more valves using less room, it does not need tape or sealant or filament and it cuts down working hours in the installations.



Llave para apretar fitting. Ver herramientas
Torque wrench to tighten fitting. See tools.





TE CON JUNTA ELECTROVÁLVULA
 ELECTRIC VALVE TEE CONNECTOR WITH JOINT
 TE POUR ELECTROVALVES AVEC JOINT
 TE COLETOR

Ref.	Ø (")		€	Dimensiones A-B-C
0413	1	- 100	4,1116	94x75x45



CRUZ CON JUNTA ELECTROVÁLVULA
 ELECTRIC VALVE CROSS CONNECTOR WITH JOINT
 CROIX POUR ELECTROVALVES AVEC JOINT
 CRUZETA COLETOR

Ref.	Ø (")		€	Dimensiones A-B-C
0423	1	- 100	6,4577	104x94x46



CODO CON JUNTA ELECTROVÁLVULA
 ELECTRIC VALVES ELBOW CONNECTORS WITH JOINT
 COUDE POUR ELECTROVALVES AVEC JOINT
 JOELHO COLETOR

Ref.	Ø (")		€	Dimensiones A-B-C
0433	1	- 100	2,7369	77x74x45



MANGUITO CON JUNTA ELECTROVÁLVULA
 ELECTRIC VALVES COUPLING CONNECTORS WITH JOINT
 MANCHON POUR ELECTROVALVES AVEC JOINT
 UNIAO COLETORA

Ref.	Ø (")		€	Dimensiones A-B-C
0443	1	- 100	2,3711	60x45x45



TAPÓN HEMBRA CON JUNTA ELECTROVÁLVULA
 ELECTRIC VALVES THREADED FEMALE PLUG WITH JOINT
 BOUNCHON FEMELLE POUR ELECTROVALVES AVEC JOINT
 TAMPÃO COLETOR

Ref.	Ø (")		€	Dimensiones A-B-C
0453	1	- 100	1,2612	25x45x45



MACHÓN CON JUNTA ELECTROVÁLVULA
 ELECTRIC VALVES THREADED MALE-MALE CONNECTOR WITH JOINT
 DOUBLE MALE POUR ELECTROVALVES AVEC JOINT
 CASQUILLO CLOLETOR

Ref.	Ø (")		€	Dimensiones A-B-C
0463	1	- 100	1,6396	40x38x38



ENLACE MICROTUBO HIDRÁULICO
HYDRAULIC MICROTUBE UNION
RACCORD MICROTUBE HYDRAULIQUE
UNIAO MICROTUBE HIDRAULIC

Ref.	Ø (mm)			€	Dimensiones A-B-C
0661	6	50	500	1,8246	48x15x15
0662	8	50	500	1,8246	48x15x15



ENLACE MICROTUBO HIDRÁULICO - ROSCA MACHO
HYDRAULIC MICROTUBE UNION - MALE THREADED
RACOORD MICROTUBE HYDRAULIQUE - FILETE
UNIAO MICROTUBE HIDRAULIC - R/M

Ref.	Ø (mm)			€	Dimensiones A-B-C
0665	6 - 1/4	50	500	1,4351	30x15x15
0666	6 - 1/8	50	500	1,4351	30x15x15
0667	8 - 1/4	50	500	1,4351	30x15x15
0668	8 - 1/8	50	500	1,4351	30x15x15



TAPÓN HIDRÁULICO
HYDRAULIC PLUG
BOUCHON HYDRAULIQUE
TACO HIDRAULICO

Ref.	Ø (mm)			€	Dimensiones A-B-C
0655	1/4	150	900	0,9737	18x13x13
0656	1/8	150	900	0,9737	17x14x14



TE NEBULIZADOR CONEXIÓN MICROTUBO
NEBULIZER TEE MICROTUBE CONNECTION
CONNEXION MICROTUBE TE NÉBULISEUR
TE NEBULIZADOR CONEXAO MICROTUBO

Ref.	Ø (mm)			€	Dimensiones A-B-C
2670	6	-	250	2,2050	
2671	8	-	250	2,2050	



TUERCA REDUCCIÓN PARA MANÓMETRO
REDUCING THREADED RACOR FOR MANOMETER
RACCORD DE REDUCTION POUR MANOMETRE
PORCA REDUCAO PARA MANOMETRO

Ref.	Ø (mm)			€	Dimensiones A-B-C
0653	1/2 - 3/8	40	400	1,8522	20x24x24
0652	1/2 - 1/8	40	400	1,8522	20x24x24
0651	1/2 - 1/4	40	400	1,8522	20x24x24





CODO NEBULIZADOR CONEXIÓN MICROTUBO
NEBULIZER ELBOW MICROTUBE CONNECTION
CONNEXION MICROTUBE COUDE NÉBULISEUR
JOELHO NEBULIZADOR CONEXAO MICROTUBO

Ref.	Ø (mm)			€	Dimensiones A-B-C
2680	6	-	250	2,1000	
2681	8	-	250	2,1000	





MACHÓN ROSCADO HIDRÁULICO
HYDRAULIC THREADED UNION
MANCHON FILETÉ HYDRAULIQUE
CASQUILHO ROSCADO HIDRAULICO

Ref.	Ø (mm)			€	Dimensiones A-B-C
0672	1/8	100	900	0,9694	23x14x14
0671	1/4	100	900	0,9694	26x14x14



MACHÓN ROSCADO HIDRÁULICO REDUCIDO
MANCHON FILETE HYDRAULIQUE REDUIT
REDUCED HYDRAULIC THREADED UNION
CASQUILHO ROSCADO HIDRAULICO REDUCIDO

Ref.	Ø (mm)			€	Dimensiones A-B-C
0675	1/8 - 1/4	100	900	0,9694	24x14x14



CODO MICROTUBO HIDRÁULICO - ROSCA MACHO
HYDRAULIC MICROTUBE ELBOW - MALE THREADED
COUDE MICROTUBE HYDRAULIQUE - FILETE
JOELHO MICROTUBO HIDRAULICO - RM

Ref.	Ø (mm)			€	Dimensiones A-B-C
0684	8 - 1/8	50	500	1,7230	26x30x15
0681	6 - 1/4	50	500	1,7230	26x30x15
0682	6 - 1/8	50	500	1,7230	25x30x15
0683	8 - 1/4	50	500	1,7230	26x30x15



TE MICROTUBO HIDRÁULICO
HYDRAULIC MICROTUBE TEE
TE MICROTUBE HYDRAULIQUE
TE MICROTUBO HIDRAULICO

Ref.	Ø (mm)			€	Dimensiones A-B-C
0691	6	25	250	2,7387	48x15x30
0692	8	25	250	2,7387	48x16x30



TE MICROTUBO HIDRÁULICO - ROSCA MACHO
HYDRAULIC MICROTUBE TEE - MALE THREADED
TE MICROTUBE HYDRAULIQUE - FILETE
TE MICROTUBO HIDRAULICO - RM

Ref.	Ø (mm)			€	Dimensiones A-B-C
0695	6 - 1/4	25	250	2,3157	48x26x15
0696	8 - 1/4	25	250	2,3157	48x26x15
0697	6 - 1/8	25	250	2,3157	48x25x15
0698	8 - 1/8	25	250	2,3157	48x25x15



TE MICROTUBO HIDRÁULICO - ROSCA MACHO LATERAL
HYDRAULIC MICROTUBE TEE - SIDE MALE THREADED
TE MICROTUBE HYDRAULIQUE - LATERAL FILETE
TE MICROTUBO HIDRAULICO - RM LATERAL

Ref.	Ø (mm)			€	Dimensiones A-B-C
0685	6 - 1/8	25	250	2,3157	
0686	6 - 1/4	25	250	2,3157	
0687	8 - 1/8	25	250	2,3157	
0688	8 - 1/4	25	250	2,3157	



DIFUSOR EMERGENTE
DIFFUSER POP-UP
DIFFUSEUR EMERGENT
DIFUSOR EMERG

Ref.	Ø (") - (°) - (")			€	Dimensiones A-B-C
2611	1/2 - (0-360°) - 3	-	50	5,9657	39x39x126

2631
2632
2633
2634
2635
2636
BOBINA RECORTABLE
CUTTABLE COIL
BOBINE AJUSTABLE
BOBINA RECORTAVEIS

Ref.	Ø (")			€	Dimensiones A-B-C
2631	1/2 - 1/2	-	150	0,5457	Con tope 24x24x148
2632	3/4 - 1/2	-	150	0,5457	Con tope 26x26x149
2633	3/4 - 3/4	-	120	0,6670	Con tope 30x30x149
2634	1/2 - 1/2	-	150	0,5457	Sin tope 24x24x148
2635	3/4 - 1/2	-	150	0,5457	Sin tope 26x26x149
2636	3/4 - 3/4	-	120	0,6670	Sin tope 30x30x149

DIFUSOR ESTÁTICO
DIFFUSER STATIC
DIFFUSEUR STATIQUE
MICRODIFUSOR ESTATICO

Ref.	Ø (")			€	Dimensiones A-B-C
2621	Tobera + Tuerca 1/2 H.	-	50	3,6576	30x30x40
2600	Tobera	-	-	2,5225	25x25x23
2601	Tuerca	-	-	1,8313	30x30x20

CARACTERÍSTICAS DEL DIFUSOR

- Regulable de 0° a 360°
- Dispone de válvula antidrenaje.
- Filtro grande que retiene la suciedad de fácil limpieza
- Muelle de acero inox. (ref. 2611)
- Hasta 700 l/h

CHARACTERISTICS OF DIFFUSER

- Adjustable from 0° to 360°
- Provide of antidrainage valve
- Large filter that retains dirt and easy cleaning
- Spring of stainless steel (ref. 2611)
- Since 700 l/h

Presion (ATM)	Radio (m)
1,5	2,2
2	2
3	3,7
3,5	4

*Datos técnicos orientativos obtenidos en nuestros laboratorios cualificados.

*Technical orientative details obtained from our qualified technical laboratories.

3705



3706
3707

TE SIMPLE Y ROSCA MACHO JARDINERIA
MALE THREADED GARDENING
TE FILETÉ JARDINAGE
TE RM JARDINAGEM

Ref.	Ø (mm)			€	Dimensiones A-B-C
3705	16	100	1000	0,5186	73x45x18
3706	1/2 /16	50	1000	0,6328	73x45x24
3707	3/4 /16	50	1000	0,6328	73x45x28



3702



3703
3704

CODO SIMPLE Y ROSCA JARDINERIA
ELBOW THREADED GARDENING
COUDE JARDINAGE
JOELHO JARDINAGEM

Ref.	Ø (mm)			€	Dimensiones A-B-C
3702	16	100	1000	0,4445	46X46X18
3703	1/2 /16	100	1000	0,6328	46X48X24
3704	3/4 /16	100	1000	0,6328	45X28X51

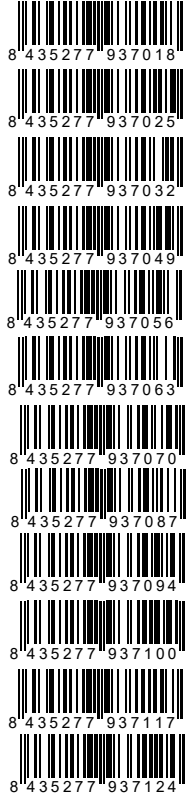

UNION ROSCA HEMBRA JARDINERIA
FEMALE THREADED UNION FUNNY PIPE
CONNEXION FEMELLE FILETÉE FUNNY PIPE
UNIÃO DE ROSCA FÊMEA JARDINAGEM

Ref.	Ø (mm)			€	Dimensiones A-B-C
3710	1/2 - 16	100	1000	0,6791	58X18X13
3711	3/4 - 16	100	1000	0,9878	



UNION ROSCA MACHO JARDINERIA
MALE THREADED UNION GARDENING
CONNEXION MÂLE FILETÉE JARDINAGE
UNIÃO DE ROSCA MACHO JARDINAGEM

Ref.	Ø (mm)			€	Dimensiones A-B-C
3708	1/2 /16	100	1000	0,4321	58X18X13
3709	3/4 /16	100	1000	0,4321	



LLAVE CLIPADA JARDINERIA
PRESSED VALVE GARDENING
VANNE PRESSE JARDINAGE
VALVULA PRESIONADA JARDINAGEM

Ref.	Ø (mm)			€	Dimensiones A-B-C
3712	16	50	700	0,9841	58x18x13



ENLACE SIMPLE JARDINERIA
SIMPLE CONNECTOR GARDENING
RACCORD JARDINAGE
UNIAO SIMPLES JARDINAGEM

Ref.	Ø (mm)			€	Dimensiones A-B-C
3701	16	100	1000	0,1882	58x18x13



MICROASPERSIÓN CIRCULAR
CIRCULAR SWING MICRO-SPRINKLER
MICROASPERSEUR CIRCULAIRE
MICROASPERSON CIRCULAR

Ref.	Cap (l/h)			€	Dimensiones A-B-C
2341	40	100	1.000	0,5093	94x75x45
2340	85	100	1.000	0,5093	94x75x45
2345	85	5	500	0,6567	94x75x45



MICROASPERSIÓN CON VARILLA
CIRCULAR SWING MICRO SPRINKLER WITH STICK
MICROASPERSEUR AVEC TIGE
CONJ MICROASP C/VARETA

Ref.	Cap (l/h)			€	Dimensiones A-B-C
2332	40	25	200	1,5815	495x37x14
2330	85	25	200	1,5815	495x37x14



TOBERA ORIENTABLE CON VARILLA
MICRO DRIP IRRIGATION SPRAY NOZZLE WITH STICK
DIFFUSEUR AVEC TIGE
DIFUSOR ORIENTAVEL CON VARETA

Ref.	Cap (l/h)			€	Dimensiones A-B-C
2310	Pinchada - 80	25	200	1,5815	495x30x12



TOBERA
MICRO DRIP IRRIGATION SPRAY NOZZLE
DIFFUSEUR
DIFUSOR

Ref.	Descripción			€	Dimensiones A-B-C
2320	Pinchada	1.000	5.000	0,1216	12x12x22
2325	Pinchada	25	2.500	0,1459	12x12x22
2322	Roscada	1.000	5.000	0,1216	11x11x23
2323	Minirrosca	1.000	5.000	0,1216	7x7x22



MICROASPERSIÓN CON ESTACA
CIRCULAR SWING MICRO SPRINKLER WITH STAKE
MICROASPERSEUR AVEC PIEU
CONJ MICROASPER C/ESTACA

Ref.	Cap (l/h)			€	Dimensiones A-B-C
2333	40	25	200	1,1878	181x37x14
2331	85	25	200	1,1878	181x37x14



TOBERA ORIENTABLE CON ESTACA
MICRO DRIP IRRIGATION SPRAY NOZZLE WITH STAKE
DIFFUSEUR AVEC PIEU
DIFUSOR ORIENTAVEL CON ESTACA

Ref.	Cap (l/h)			€	Dimensiones A-B-C
2312	Pinchada - 80	25	200	1,1190	167x30x13



ASPERSOR ROTOR MINI
MINI ROTARY SPRINKLER
MINI ASPERSEUR ROTATIF
ASPERSOR ROTOR MINI

Ref.	Ø (Boq - ")			€	Dimensiones A-B-C
2655	3,25 - 1/2	-	200	1,1885	30x30x63



MODELO PATENTADO

ASPERSOR ROTOR PLUS
ROTATOR SPRINKLER PLUS
ASPERSEUR ROTATIF PLUS
ASPERSOR ROTOR PLUS

Ref.	Ø (")			€	Dimensiones A-B-C
2660	2,5 - 1/2	-	50	11,5211	69x69x132
2661	3,25 - 1/2	-	50	11,5211	69x69x131
2662	4 - 1/2	-	50	11,5211	
2663	5 - 1/2	-	50	11,5211	64x64x132

TABLAS ORIENTATIVAS

*Microaspersores probados a 2 atm de presión, sobre estaca de 50 cm. Datos técnicos orientativos obtenidos en nuestros laboratorios por técnicos cualificados.
Diameter of micro sprinklers obtained at 2 atm off pressure, on 50 cm stake. Technical orientative details obtained from our qualified technical laboratories

MICROASPERSION SÚPER

NORMAL

	Caudal	Radio (m)
	70	2,60
	100	2,85
	150	2,90

ANTI-INSECTO

	Caudal	Radio (m)
	70	3,30
	100	3,80
	150	3,90

360°

	Caudal	Radio (m)
	30	1,20
	70	2,00
	100	2,10
150	2,40	

GRANDE

	Caudal	Radio (m)
	70	4,10
	100	4,40
	150	3,95

90°

	Caudal	Radio (m)
	30	2,20
	70	3,20
	100	3,30
150	3,50	

Rayos

	Caudal	Radio (m)
	30	0,75
	70	1,10
	100	1,20
150	1,30	

INVERTIDO

	Caudal	Radio (m)
	70	3,10
	100	3,35
	150	3,55

180°

	Caudal	Radio (m)
	30	1,60
	70	2,15
	100	2,40
150	2,50	

Sectorial

	Caudal	Radio (m)
	30	1,50
	70	2,60
	100	2,80
150	3,20	

ASPERSOR ROTOR PLUS

	Referencia		Presión (atm)		
			1	1,5	2
2660		Caudal (l/h)	216	250	279
		Radio (m)	5,35	5,85	6,25
2661		Caudal (l/h)	388	450	502
		Radio (m)	5,85	6,25	6,5
2662		Caudal (l/h)	618	713	797
		Radio (m)	6,25	6,5	6,7
2663		Caudal (l/h)	899	1.038	1.161
		Radio (m)	6,35	6,8	6,85



CON LIMITADOR DE RADIO

	Caudal	Radio (m) sin pestaña	Radio (m) con pestaña
	70	3,35	0,75
	100	3,56	0,75
	150	3,75	0,75

ASPERSOR ROTOR MINI

	Referencia		Presion 1,5 atm	
	2655		Caudal (l/h)	460
			Radio (m)	11,1

MICROASPERSIÓN CIRCULAR

	Ref.	Presion (atm)	Radio (m)	Caudal (l/h)		Ref.	Presion (atm)	Radio (m)	Caudal (l/h)
	2332, 2341	0,5	1,10	23		2340, 2345, 2330, 2331	0,5	1,70	60
		1	1,35	33			1	2,20	85
		1,5	1,50	41			1,5	2,60	110
		2	1,60	48			2	2,80	125
	2,5	1,80	53		2,90	135			



Tabla de caudales en pagina 23
Flow table on page 23



Tabla de caudales en pagina 23
Flow table on page 23

MICROASPERSIÓN SÚPER BAILARINA SUPER MICRO SPLINKER SUPER MICROASPERSEUR MICROASPERSONOR SUPER BAILARINA

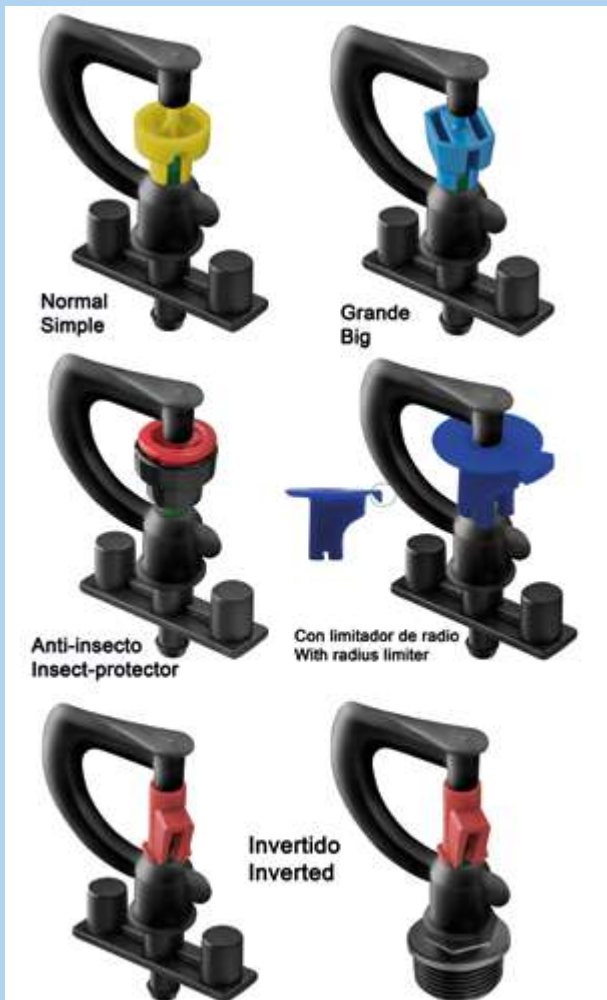
Ref.	Cap (l/h)			€	Dimensiones A-B-C
3211	70	100	1.000	0,4608	NORMAL SIMPLE
3212	100	100	1.000	0,4608	
3213	150	100	1.000	0,4608	
3221	70	100	1.000	0,4608	GRANDE BIG
3222	100	100	1.000	0,4608	
3223	150	100	1.000	0,4608	
3231	70	100	1.000	0,4608	INVERTIDA INVERTED
3232	100	100	1.000	0,4608	
3233	150	100	1.000	0,4608	
3235	70	100	1.000	0,4608	INVERTIDA - ROSCA MACHO INVERTED - MALE
3236	100	100	1.000	0,4608	
3237	150	100	1.000	0,4608	
3241	70	100	1.000	0,5578	ANTI-INSECTO INSECT PROTECTOR
3242	100	100	1.000	0,5578	
3243	150	100	1.000	0,5578	
2690	70	100	1.000	0,5578	CON LIMITADOR DE RADIO WITH RADIUS LIMITER
2691	100	100	1.000	0,5578	
2692	150	100	1.000	0,5578	

MICROASPERSIÓN SÚPER DIFUSOR SUPER MICRO DIFUSOR SUPER MICRODIFFUSEUR MICROASPERSONOR SUPER DIFUSOR

Ref.	Cap (l/h)			€	Dimensiones A-B-C
3260	30	100	1.000	0,4608	90°
3261	70	100	1.000	0,4608	
3262	100	100	1.000	0,4608	
3263	150	100	1.000	0,4608	
3270	30	100	1.000	0,4608	180°
3271	70	100	1.000	0,4608	
3272	100	100	1.000	0,4608	
3273	150	100	1.000	0,4608	
3250	30	100	1.000	0,4608	360°
3251	70	100	1.000	0,4608	
3252	100	100	1.000	0,4608	
3253	150	100	1.000	0,4608	
3280	30	100	1.000	0,4608	RAYOS WATER WAY
3281	70	100	1.000	0,4608	
3282	100	100	1.000	0,4608	
3283	150	100	1.000	0,4608	
3290	30	100	1.000	0,4608	SECTORIAL BY ZONES
3291	70	100	1.000	0,4608	
3292	100	100	1.000	0,4608	
3293	150	100	1.000	0,4608	



Tabla de caudales en pagina 23
Flow table on page 23

Tabla de caudales en pagina 23
Flow table on page 23

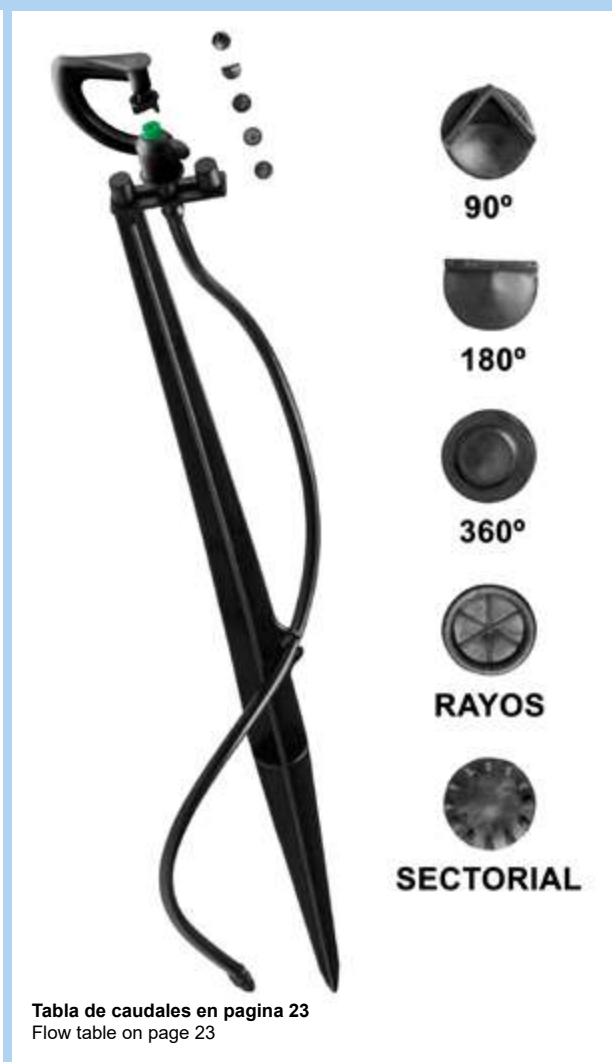
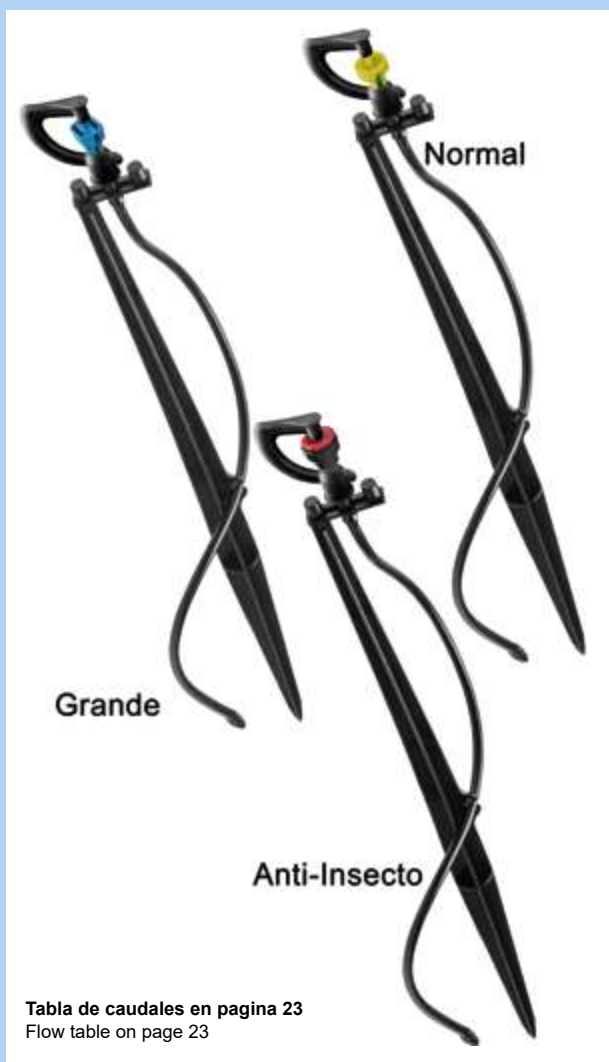

MICROASPERSIÓN SÚPER BAILARINA C/ESTACA
SUPER MICRO SPLINKER STAKE MOUNTED
SUPER MICROASPERSEUR AVEC PIEU
MICROASPERSON SUPER BAILARINA C/ESTACA

Ref.	Cap (l/h)			€	Dimensiones A-B-C
3215	70	25	250	1,7585	NORMAL SIMPLE
3216	100	25	250	1,7585	
3217	150	25	250	1,7585	

Ref.	Cap (l/h)			€	Dimensiones A-B-C
3225	70	25	250	1,7585	GRANDE BIG
3226	100	25	250	1,7585	
3227	150	25	250	1,7585	

Ref.	Cap (l/h)			€	Dimensiones A-B-C
3245	70	25	250	1,8798	ANTI-INSECTO INSECT
3246	100	25	250	1,8798	
3247	150	25	250	1,8798	

MICROASPERSIÓN SÚPER DIFUSOR C/ESTACA
SUPER MICRO DIFUSER STAKE MOUNTED
SUPER MICRODIFFUSEUR AVEC PIEU
MICROASPERSON SUPER DIFUSOR C/ESTACA

Ref.	Cap (l/h)			€	Dimensiones A-B-C
3264	30	25	250	1,7585	90°
3265	70	25	250	1,7585	
3266	100	25	250	1,7585	
3267	150	25	250	1,7585	

3274	30	25	250	1,7585	180°
3275	70	25	250	1,7585	
3276	100	25	250	1,7585	
3277	150	25	250	1,7585	

3254	30	25	250	1,7585	360°
3255	70	25	250	1,7585	
3256	100	25	250	1,7585	
3257	150	25	250	1,7585	

3284	30	25	250	1,7585	RAYOS WATER WAY
3285	70	25	250	1,7585	
3286	100	25	250	1,7585	
3287	150	25	250	1,7585	

3294	30	25	250	1,7585	SECTORIAL BY ZONES
3295	70	25	250	1,7585	
3296	100	25	250	1,7585	
3297	150	25	250	1,7585	



ACCESORIOS ACCESSORIES COMPLMENTS ACCESORIOS

Ref.	Ø (")			€	Dimensiones A-B-C
2365	1/2"	-	500	0,3395	
2363	1/2 - 12 mm	-	500	0,6414	45x28x57
2364	1/2 - 16 mm	-	500	0,6414	45x28x63
2352	Sop. Tobera	1	1.000	0,3060	29x9x13
2353	Microtubo	-	1.500	0,7068	5x5
0106	1/4 - 63 DN	-	54	42,9975	61X29X92 (-+)

VARILLAS Y ESTACAS BARS AND STAKE TIGES ET PIEUS VARETAS Y ESTACAS

Ref.	Descripción			€	Dimensiones A-B-C
2350	45 cm	-	1.000	0,5163	6x6x50
2351	13 cm	-	1.000	0,3060	8x8x133
2357	35 cm	-	400	0,8246	51x51x343
2358	35 cm	-	600	0,6973	51x51x343
2370	35 cm	-	400	0,6973	51x51x343
2355	45 cm	-	500	0,6791	21x21x400



VENTOSA DOBLE EFECTO MACHO CON MUELLE
AIR RELEASE VALVE DOUBLE EFFECT MALE WITH SPRING
SOUPAPE DE DÉTENTE DE DOBLE EFFET MÂLE
VENTOSA DUPLO EFEITO RM

VENTOSA DOBLE EFECTO
AIR RELEASE VALVE DOUBLE EFFECT
SOUPAPE DE DÉTENTE DE DOBLE EFFET
VALVULA DUPLA EFEITO

Ref.	Ø (")		€	Dimensiones A-B-C
0721	1/2	- 250	1,0914	23x23x46
0723	1	- 50	10,6722	35x35x46
0726	2	- 20	18,1912	62x62x45

Ref.	Ø (")		€	Dimensiones A-B-C
0731	16 - Manguera	- 200	1,1521	55x27x27
0741	16 - Cinta	- 200	1,1521	56x27x27
0761	16	- 200	0,8269	
0762	20	- 200	0,8826	



Disponemos de recambios de membranas

DISPONIBLE AVAILABLE NPT

VENTOSA TRIPLE EFECTO MACHO ALTA PRESIÓN
AIR RELEASE VALVE TRIPLE EFFECT MALE
SOUPAPE DE DÉTENTE DE TRIPLE EFFET
VENTOSA TRIPLO EFEITO

VENTOSA TRIPLE EFECTO MACHO
AIR RELEASE VALVE TRIPLE EFFECT MALE
SOUPAPE DE DÉTENTE DE TRIPLE EFFET
VENTOSA TRIPLO EFEITO

Ref.	Ø (")		€	Dimensiones A-B-C
0763	3/4	- 25	37,5327	41x57x120
0764	1	- 25	37,3527	47x57x120
0765	2	- 25	16,7220	81x93x170
0766	2 (NPT)	- 25	16,7220	81x93x120
0767	1 (NPT)	- 25	37,3527	47x57x120

Ref.	Ø (")		€	Dimensiones A-B-C
0751	1/2	- 50	7,7175	
0752	3/4	- 25	33,9570	41x57x120
0753	1	- 25	33,9570	47x57x120
0754	2	- 25	97,0200	81x93x170
0755	2 (NPT)	- 25	97,0200	81x93x120
0756	1 (NPT)	- 25	33,9570	47x57x120

*Los artículos NPT se fabricarán bajo pedido, USA.

UNIÓN SIMPLE

Idóneo para unir tubos a un bajo coste. Está fabricado en Polipropileno (PP)

SIMPLE UNION

Ideal for joining pipes at a low cost. It is made of Polypropylene (PP)



UNIÓN 4 PUNTAS

Mejor sujeción gracias a su diseño exclusivo. Está fabricado en Resina Acetalica (POM)

4 POINTED UNION

Best fixing thanks to its unique design. It is made fromacetal resin. (POM)



UNIÓN 4 SEGURIDAD

La anilla se abre en su cuerpo cónico reteniendo a la manguera en la unión.

SAFETY UNION

The ring opens its conical body holding the tubin in union.



UNIÓN ACETAL

Mejor sujeción gracias a su diseño exclusivo. Está fabricado en Resina Acetalica (POM).

ACETAL UNION

Best fixing thanks to its unique design. It is made fromacetal resin. (POM)



UNIÓN COMPRESIÓN

Sujección máxima, la tuerca compresiona a la manguera con el cuerpo de la unión.

COMPRESSION UNION

Maximum fixing. The thread presses the tube with de union body

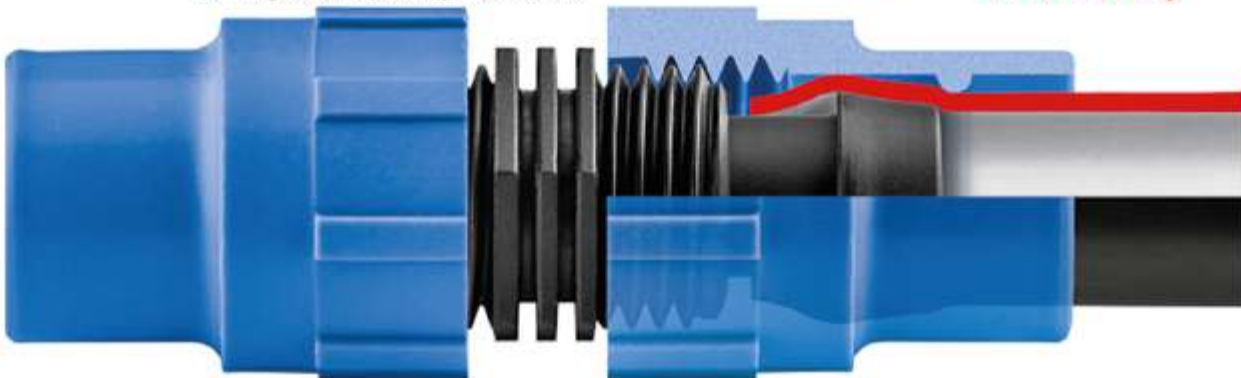



ENLACE-TOMA MICROTUBO ACETAL
MICROTUBE INTAKE CONNECTOR ACETAL
JUNCTION MICROTUBE DEPART ACETAL
UNIAO TOMA ACETAL

Ref.	Ø (mm)			€	Dimensiones A-B-C
0823	3x3	1.000	10.000	0,0345	23x7x7
0820	5x3	1.000	10.000	0,0345	22x7x7
0821	5x5	1.000	10.000	0,0345	19x7x11
0826	5x5	50	5.000	0,1008	19x7x11
0822	6x6	1.000	10.000	0,0413	20x7x7



LLAVE MICROTUBO ACETAL
ACETAL MICROTUBE VALVE
VANNE EN ACETAL MICROTUBE
CHAVE MICROTUBO ACETAL

Ref.	Ø (mm)			€	Dimensiones A-B-C
0851	5x5	100	500	0,7797	24x23x15
0860	3x3	100	500	1,0473	Clipado
0861	5x5	100	500	0,8268	Clipado
0862	6x6	100	500	1,3230	Clipado



CODO MICROTUBO ACETAL
MICROTUBE ELBOW ACETAL
COUDE MICROTUBE ACETAL
JOELHO MICROTUBO ACETAL

Ref.	Ø (mm)			€	Dimensiones A-B-C
0833	3x3	1.000	10.000	0,1764	19x19x7
0831	5x5	1.000	10.000	0,1381	20x20x7
0836	5x5	50	5.000	0,2878	20x20x7
0834	6x6	1.000	10.000	0,1764	18x18x7



TE MICROTUBO ACETAL
MICROTUBE TEE ACETAL
TE MICROTUBE ACETAL
TE MICROTUBO ACETAL

Ref.	Ø (mm)			€	Dimensiones A-B-C
0843	3x3	1.000	10.000	0,2878	34x19x7
0841	5x5	1.000	10.000	0,0968	29x17x5
0846	5x5	50	5.000	0,2878	30x17x6
0844	6x6	1.000	10.000	0,2878	30x18x7



ENLACE SIMPLE
SIMPLE CONNECTOR
RACCORD
UNIAO SIMPLES

Ref.	Ø (mm)			€	Dimensiones A-B-C
0911	16	100	2.000	0,0788	65x17x17
0919	16	10	1.000	0,0956	64x17x17
0912	18	100	2.000	0,1274	53x17x17
0913	20	100	2.000	0,1593	65x21x21
0914	25	-	500	0,7963	82x25x25
0915	32	-	500	0,9560	83x33x33
0916	40	-	250	1,1140	102x42x42
0917	50	-	100	1,4020	123x51x51
0918	63	-	100	1,5296	123x64x64

UNIÓN ROSCA MACHO SIMPLE
MALE THREADED CONNECTOR
RACCORD FILETE MALE
UNIAO RM SIMPLES

Ref.	Ø (mm)			€	Dimensiones A-B-C
0971	1/2 - 16	100	2.000	0,2231	47x19x19
0979	1/2 - 16	5	1.000	0,2676	47x19x19
0973	1/2 - 20	100	2.000	0,2676	50x22x22
0974	3/4 - 25	-	500	0,7963	60x25x25
0975	1 - 32	-	500	0,9560	64x55x55
0976	1 1/4 - 40	-	250	1,1140	79x42x42
0977	1 1/2 - 50	-	100	1,4020	92x51x51
0978	2 - 63	-	100	1,5296	97x62x62

ENLACE REDUCIDO SIMPLE
REDUCED CONNECTOR
RACCORD REDUIT
UNIAO REDUCAO

Ref.	Ø (mm)			€	Dimensiones A-B-C
0920	16 - 12	100	2.000	0,1159	56x16x16
0922	20 - 12	100	2.000	0,2737	56x17x17
0921	20 - 16	100	2.000	0,1966	56x18x18

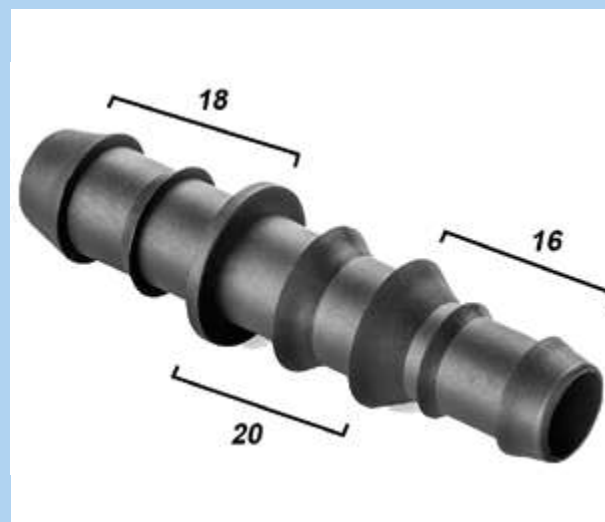
ENLACE REDUCIDO SIMPLE
REDUCED CONNECTOR
RACCORD REDUIT
UNIAO REDUZIDA ACETAL

Ref.	Ø (mm)			€	Dimensiones A-B-C
0923	18 - 20 - 16	50	500	0,5700	83x19x19



TOMA NORMAL SIMPLE
STANDARD INTAKE
DEPART NORMAL
TOMADA NORMAL

Ref.	Ø (mm)			€	Dimensiones A-B-C
0951	16	100	2.000	0,0788	42x17x17
0956	16	10	1.000	0,0956	42x17x17
1451	17	100	2.000	0,1611	45x16x16
0952	18	100	2.000	0,1593	51x17x17
0953	20	100	2.000	0,1593	50x17x17



TOMA GRAN CAUDAL SIMPLE
GREAT FLOW INTAKE
RACCORD GRAN DEBIT
TOMA GRAN CAUDAL

Ref.	Ø (mm)			€	Dimensiones A-B-C
0960	16	100	2.000	0,0788	47x17x17
0961	20	100	2.000	0,1593	52x22x22



CODO SIMPLE
ELBOW
COUDE
JOELHO

Ref.	Ø (mm)			€	Dimensiones A-B-C
0931	16	100	1.000	0,1734	40x40x16
0936	16	5	500	0,2287	40x40x16
0933	20	100	1.000	0,2287	46x46x19
0934	25	-	500	0,9702	60x60x25
0935	32	-	500	1,3582	70x70x35
0937	40	-	150	1,8191	88x88x43
0938	50	-	100	2,1829	112x112x50
0939	63	-	50	3,3957	116x116x63



TE SIMPLE
TEE
TE
TE

Ref.	Ø (mm)			€	Dimensiones A-B-C
0941	16	100	1.000	0,1734	59x35x15
0946	16	5	500	0,2086	59x35x15
0942	18	100	1.000	0,2731	63x40x17
0944	25	-	200	0,9702	105x63x26
0945	32	-	200	1,3582	115x70x35
0947	40	-	150	1,8191	151x93x43
0948	50	-	100	3,0318	184x114x50
0949	63	-	50	4,2446	194x126x63





TOMA GRAN CAUDAL 4 PUNTAS ACETAL
GREAT FLOW INTAKE WITH 4 POINTED ACETAL
RACCORD GRAN DEBIT AVEC 4 POINTES ACETAL
TOMA GRAN CAUDAL 4 PONTAS ACETAL

Ref.	Ø (mm)			€	Dimensiones A-B-C
1011	16	100	2.000	0,0985	50x17x17
1016	16	10	1.000	0,1183	50x17x17



ENLACE 4 PUNTAS ACETAL
CONNECTOR WITH 4 POINTED ACETAL
RACCORD AVEC 4 POINTES ACETAL
UNIAO 4 PONTAS ACETAL

Ref.	Ø (mm)			€	Dimensiones A-B-C
1021	16	100	2.000	0,0985	59x17x17
1026	16	10	1.000	0,1183	59x17x17



CODO 4 PUNTAS ACETAL
ELBOW WITH 4 POINTED ACETAL
COUDE AVEC 4 POINTES ACETAL
JOELHO 4 PONTAS ACETAL

Ref.	Ø (mm)			€	Dimensiones A-B-C
1031	16	100	1.000	0,1947	43x43x18
1036	16	5	500	0,2142	43x43x18



TE 4 PUNTAS ACETAL
TEE WITH 4 POINTED ACETAL
TE AVEC 4 POINTES ACETAL
TE 4 PONTAS ACETAL

Ref.	Ø (mm)			€	Dimensiones A-B-C
1041	16	100	1.000	0,2609	77x45x17
1046	16	5	500	0,2869	77x45x17

DISPONEMOS DE TODAS
LAS MEDIDAS



2360

3053
3054

DISPONEMOS DE TODAS
LAS MEDIDAS



2361

3051



ACOPLE ACETAL A MANGUERA

ACETAL COUPLING UNION FOR HOSE OUTPUT

RACCORD EMBOUTI EN ACETAL POUR TUYAU

ACOPLE MANGUERA ACETAL

TOMA ADAPTADOR ACETAL

ACETAL ADAPTER INTAKE

ADAPTATEUR DEPART EN ACETAL

TOMA CUELLO ACOPLE ACETAL

Ref.	Ø (")			€	Dimensiones A-B-C
2360	12 - T. Normal	100	2.000	0,0788	38x10x14
3053	16 - T. Gran Caudal	100	2.000	0,1323	44x13x18
3054	20 - T. Gran Caudal	100	2.000	0,1323	46x12x21

Ref.	Ø (")			€	Dimensiones A-B-C
2361	Toma Normal	100	2.000	0,0788	17x12x14
3051	T. Gran Caudal	100	2.000	0,1323	24x13x18

DISPONEMOS DE TODAS
LAS MEDIDAS



3052

2362

DISPONEMOS DE TODAS
LAS MEDIDAS



3055

3056

TAPÓN ACETAL

ACETAL PLUG

BOUNCHON EN ACETAL

TAPON ACOPLE ACETAL

ACOPLE ACETAL A CINTA

ACETAL COUPLING UNION FOR TAPE OUTPUT

RACCORD EMBOUTI EN ACETAL POUR TUYAU PLAT

ACOPLE CINTA ACETAL

Ref.	Ø (")			€	Dimensiones A-B-C
2362	Toma Normal	100	2.000	0,0788	23x14x14
3052	T. Gran Caudal	100	2.000	0,1323	25x17x17

Ref.	Ø (")			€	Dimensiones A-B-C
3055	16 - T. Gran Caudal	100	2.000	0,3087	Roscada
3056	16 - T. Gran Caudal	100	2.000	0,3087	Extra



ENLACE ACETAL
ACETAL UNION
RACCORD EN ACETAL
UNIAO ACETAL

Ref.	Ø (mm)			€	Dimensiones A-B-C
1052	12	100	2.000	0,0717	52x12x12
1055	16	100	2.000	0,1063	59x13x18
1050	16	100	2.000	0,1344	59x13x18
1054	16	100	2.000	0,1344	59x13x18
3036	16	10	1.000	0,1276	59x13x18
1053	17	100	2.000	0,1479	59x13x18
1059	18	100	2.000	0,1298	58x13x18
1058	20	100	2.000	0,1300	64x21x21



ENLACE ACETAL REDUCIDO
ACETAL REDUCED UNION
RACCORD REDUIT EN ACETAL
UNIAO ACETAL REDUZIDA

Ref.	Ø (mm)			€	Dimensiones A-B-C
1056	17 - 16	100	2.000	0,1561	58x13x18
1057	20 - 16	100	2.000	0,2090	61x21x21



TOMA NORMAL ACETAL
ACETAL NORMAL INTAKE
DEPART NORMAL EN ACETAL
TOMADA NORMAL ACETAL

Ref.	Ø (mm)			€	Dimensiones A-B-C
1062	12	100	2.000	0,0717	40x14x11
1066	16	100	2.000	0,1063	45x18x13
1060	16	100	2.000	0,1344	45x18x13
1064	16	100	2.000	0,1344	45x18x13
3035	16	10	1.000	0,1339	45x18x13
1063	17	100	2.000	0,1479	45x18x13
1061	17	100	2.000	0,1479	45x18x13
1069	18	100	2.000	0,1298	45x18x13
A1049	20	100	2.000	0,1300	45x18x13



TOMA GRAN CAUDAL ACETAL
ACETAL GREAT FLOW INTAKE
DEPART GRAND DEBIT EN ACETAL
TOMADA GRAN CAUDAL ACETAL

Ref.	Ø (mm)			€	Dimensiones A-B-C
1076	16	100	2.000	0,1063	51x18x13
1070	16	100	2.000	0,1344	51x18x13
1074	16	100	2.000	0,1344	51x18x13
1073	17	100	2.000	0,1479	51x18x13
1071	17	100	2.000	0,1479	51x18x13
1079	18	100	2.000	0,1298	51x18x13
1078	20	100	2.000	0,1300	55x21x21



TOMA MICRO ACETAL
ACETAL MICRO INTAKE
MICRO DEPART EN ACETAL
TOMADA MICRO ACETAL

Ref.	Ø (mm)			€	Dimensiones A-B-C
1072	12 x 5	100	2.000	0,0717	39x14x10
1068	16 x 5	100	2.000	0,1344	41x18x13



CODO ACETAL
ACETAL ELBOW
COUDE EN ACETAL
JOELHO ACETAL

Ref.	Ø (mm)			€	Dimensiones A-B-C
1082	12	100	1.000	0,1246	38x38x14
1067	16	100	1.000	0,2513	44x44x19
1080	16	100	1.000	0,3175	44x44x19
1084	16	100	1.000	0,3175	44x44x19
3037	16	5	500	0,3016	44x44x19
1083	17	100	1.000	0,3704	44x44x19
1081	17	100	1.000	0,3704	44x44x19
1089	18	100	1.000	0,3500	45x45x19
1088	20	100	1.000	0,3528	50x50x22



CODO TOMA GRAN CAUDAL ACETAL
ELBOW WITH GREAT FLOW INTAKE ACETAL
COUDE DEPART GRAND DEBIT EN ACETAL
JOELHO TOMA GRAN CAUDAL ACETAL

Ref.	Ø (mm)			€	Dimensiones A-B-C
3085	16	100	1.000	0,4520	



CODO ROSCA MACHO ACETAL
ACETAL MALE THREADED ELBOW
COUDE FILETÉ ACETAL
JOELHO RM ACETAL

Ref.	Ø (mm - ")			€	Dimensiones A-B-C
3070	16 - 1/2	100	1.000	0,4520	43x43x21
3071	16 - 3/4	100	1.000	0,4520	44x44x24
3072	20 - 1/2	100	1.000	0,5181	
3073	20 - 3/4	100	1.000	0,5181	



TE ACETAL
ACETAL TEE
TE EN ACETAL
TE ACETAL

Ref.	Ø (mm)			€	Dimensiones A-B-C
1092	12	100	1.000	0,1298	45x37x14
1077	16	100	1.000	0,2932	74x43x19
1090	16	100	1.000	0,3704	74x43x19
1094	16	100	1.000	0,3704	74x43x19
3038	16	5	500	0,3519	74x43x19
1093	17	100	1.000	0,4233	74x43x19
1091	17	100	1.000	0,4233	74x43x19
1099	18	100	1.000	0,3687	74x43x20
1098	20	50	1.000	0,3969	83x51x22



TE REDUCIDA ACETAL
ACETAL TEE REDUCED
TE EN ACETAL POUR REDUCCION
TE ACETAL REDUZIDA

Ref.	Ø (mm - ")			€	Dimensiones A-B-C
3031	16 - 12 - 16	100	1.000	0,4520	
3030	16 - 20 - 16	100	1.000	0,4520	
3033	20 - 12 - 20	50	1.000	0,5181	
3032	20 - 16 - 20	50	1.000	0,5181	



TE CON TOMA GRAN CAUDAL ACETAL
TEE WITH GREAT FLOW INTAKE ACETAL
TE DEPART GRAND DEBIT EN ACETAL
TE TOMA GRAN CAUDAL ACETAL

Ref.	Ø (mm)			€	Dimensiones A-B-C
3080	16	100	1.000	0,4520	



TE ROSCA MACHO ACETAL
ACETAL MALE THREADED TEE
TE FILETÉ ACETAL
TE RM ACETAL

Ref.	Ø (mm - ")			€	Dimensiones A-B-C
3060	16 - 1/2 - 16	50	1.000	0,4520	
3061	16 - 3/4 - 16	50	1.000	0,4520	
3062	20 - 1/2 - 20	50	500	0,5181	
3063	20 - 3/4 - 20	50	500	0,5181	



UNIÓN ROSCA MACHO ACETAL
MALE THREADED ACETAL CONNECTOR
RACCORD FILETE MALE ACETAL
UNIAO RM ACETAL

Ref.	Ø (mm - ")		€	Dimensiones A-B-C
3024	1/2 - 12	100 2.000	0,2028	38x21x21
3020	1/2 - 16	100 2.000	0,3087	42x21x21
3039	1/2 - 16	10 1.000	0,3519	42x21x21
3021	1/2 - 20	100 2.000	0,3087	45x26x26
3022	3/4 - 16	100 2.000	0,3087	45x26x26
3023	3/4 - 20	100 2.000	0,3087	47x26x26



UNIÓN ROSCA HEMBRA ACETAL CON TUERCA LOCA
ACETAL ROTATING FEMALE THREADED UNION
RACCORD EN ACETAL ECROU TOURNANT
UNIAO ROSCA FEMEA COM PORCA LOCA

Ref.	Ø (mm - ")		€	Dimensiones A-B-C
3012	3/4 - 5	100 1.000	1,4222	42x38x38
3018	3/4 - 5	5 500	1,7066	42x38x38
3010	1/2 - 16	100 1.000	0,4851	41x28x28
3016	1/2 - 16	5 500	0,5821	41x28x28
3011	3/4 - 16	50 1.000	0,7056	40x38x38
3017	3/4 - 16	5 500	0,8467	40x38x38
3013	3/4 - 20	100 1.000	0,7056	46x38x38



CRUZ ACETAL
ACETAL CROSS
CROIX EN ACETAL
CRUZETA ACETAL

Ref.	Ø (mm)		€	Dimensiones A-B-C
3040	25	- 100	1,9500	103x103x24
3041	32	- 100	2,4900	133X133X30



CRUZ ROSCA MACHO ACETAL
MALE THREADED ACETAL CROSS
CROIX EN ACETAL FILETE MALE
CRUZETA ROSCA MACHO ACETAL

Ref.	Ø (" - mm)		€	Dimensiones A-B-C
3044	3/4-25	- 100	1,9500	
3045	1"-32	- 100	2,4900	134X133X38





8 435277 910653



8 435277 910752



8 435277 910851



8 435277 910868



8 435277 910875



8 435277 910950



8 435277 910967



8 435277 910974



“Y” ACETAL 2 SALIDAS A MANGUERA
ACETAL “Y” 2 OUTPUTS - HOSE
“Y” 2 RACCORDS EN ACETAL - TUYAU
“Y” ACETAL 2 SAIDAS - MANGUEIRA

Ref.	Ø (mm)			€	Dimensiones A-B-C
1085	16 / 16 - 16	50	500	0,5830	72x69
1065	20 / 16 - 16	50	500	0,5830	78x69



“Y” ACETAL 3 SALIDAS A MANGUERA
ACETAL “Y” 3 OUTPUTS - HOSE
“Y” 3 RACCORDS EN ACETAL - TUYAU
“Y” ACETAL 3 SAIDAS - MANGUEIRA

Ref.	Ø (mm)			€	Dimensiones A-B-C
1095	16 / 16 - 16 - 16	50	500	0,6361	77x70
1075	20 / 16 - 16 - 16	50	500	0,6361	81x70



“Y” ACETAL TOMA GRAN CAUDAL 2 SALIDAS A MANGUERA
ACETAL “Y” 2 OUTPUTS - GREAT FLOW INTAKE
“Y” 2 RACCORDS EN ACETAL - GRAND DEBIT
“Y” ACETAL 2 SAIDAS - TOMA GRAN CAUDAL

Ref.	Ø (mm)			€	Dimensiones A-B-C
1086	16	50	500	0,5830	67x69



“Y” ACETAL TOMA GRAN CAUDAL 3 SALIDAS A MANGUERA
ACETAL “Y” 3 OUTPUTS - GREAT FLOW INTAKE
“Y” 3 RACCORDS EN ACETAL - GRAND DEBIT
“Y” ACETAL 3 SAIDAS - TOMA GRAN CAUDAL

Ref.	Ø (mm)			€	Dimensiones A-B-C
1096	16	50	500	0,6361	71x70



“Y” ACETAL ROSCA MACHO 2 SALIDAS A MANGUERA
ACETAL “Y” 2 OUTPUTS - MALE THREADED
“Y” 2 RACCORDS EN ACETAL - MALE FILETE
“Y” ACETAL 2 SAIDAS - RM

Ref.	Ø (” - mm)			€	Dimensiones A-B-C
1087	1/2 / 16 - 16	50	500	0,5830	61x70





“Y” ACETAL ROSCA MACHO 3 SALIDAS A MANGUERA
ACETAL “Y” 3 OUTPUTS - MALE THREADED
“Y” 3 RACCORDS EN ACETAL - MALE FILETE
“Y” ACETAL 3 SAIDAS - RM



Ref.	Ø (” - mm)			€	Dimensiones A-B-C
1097	3/4 / 16 - 16 - 16	50	500	0,6361	68x69



JUNTA BILABIAL
TWO LIPS JOINT
JOINT DEUX LÈVRES
BORRACHA BILABIAL

JUNTA SIMPLE
SIMPLE JOINT
JOINT SIMPLE
BORRACHA SIMPLE

Ref.	Ø (")			€	Dimensiones A-B-C
0980	Toma Nomal	100	2.000	0,2044	17x17x12
0981	Toma Gran Caudal	100	2.000	0,2552	24x24x14

Ref.	Ø (")			€	Dimensiones A-B-C
0990	Microtubo	500	4.000	0,1261	9x9x7
0991	Normal	100	4.000	0,1261	17x17x13
0992	Toma Gran Caudal	100	4.000	0,1513	21x21x17



JUNTA BILABIAL:

Se aconseja que en las tuberías de PVC, o de durezas similares, se limen los cantos vivos de los orificios antes de su montaje. Para un correcto funcionamiento es necesario que la persona que lo instale conozca estos consejos.

BILABIAL JOINT:

It is advisable to smooth the limit of PVC pipes' exits or those made of similar hardness before the installation. Anyone who wish to install it needs to know this for better performance



ENLACE DE SEGURIDAD
UNION WITH SAFETY RING
RACCORD DE SÉCURITÉ
UNIAO SEGURANÇA

Ref.	Ø (mm)			€	Dimensiones A-B-C
1110	12	100	2.000	0,1825	55x14x14
1111	16	100	2.000	0,1953	59x16x16
1116	16	10	1.000	0,2342	59x16x16
1112	18	100	2.000	0,2738	56x17x17
1113	20	100	2.000	0,2738	62x19x19



ENLACE REDUCIDO DE SEGURIDAD
REDUCED UNION WITH SAFETY RING
RACCORD REDUIT DE SÉCURITÉ
UNIAO REDUZIDA SEGURANÇA

Ref.	Ø (mm)			€	Dimensiones A-B-C
1120	16 - 12	100	2.000	0,2436	57x15x15
1121	20 - 16	100	2.000	0,2738	68x22x22
1122	20 - 12	100	2.000	0,4257	61x22x22
0923	18 - 20 - 16	50	500	Pag 30	83x19x19



TOMA NORMAL SEGURIDAD
NORMAL INTAKE WITH SAFETY RING
DEPART DE SÉCURITÉ
TOMADA SEGURANÇA NORMAL

Ref.	Ø (mm)			€	Dimensiones A-B-C
1130	12	100	2.000	0,1216	40x16x16
1131	16	100	2.000	0,1516	49x16x16
1136	16	10	1.000	0,1672	49x16x16
1133	20	100	2.000	0,1825	48x22x22



TOMA GRAN CAUDAL DE SEGURIDAD
GREAT FLOW INTAKE WITH SAFETY RING
DEPART GRAND DÉBIT DE SÉCURITÉ
TOMADA SEGURANÇA GRAN CAUDAL

Ref.	Ø (mm)			€	Dimensiones A-B-C
1140	12	100	2.000	0,1216	47x16x16
1141	16	100	2.000	0,1521	49x16x16
1142	18	100	2.000	0,1825	48x17x17
1143	20	100	2.000	0,1825	51x22x22



TOMA GRAN CAUDAL SEGURIDAD ACETAL
ACETAL GREAT FLOW INTAKE WITH SAFETY RING
DEPART GRAND DEBIT DE SÉCURITÉ EN ACETAL
TOMADA SEGURANÇA GRAN CAUDAL ACETAL

Ref.	Ø (mm)		€	Dimensiones A-B-C
1144	16	100 2.000	0,1516	51x21x21



CODO SEGURIDAD
ELBOW WITH SAFETY RING
COUDE DE SÉCURITÉ
JOELHO SEGURANÇA

Ref.	Ø (mm)		€	Dimensiones A-B-C
1082	12	100 1.000	Pag 35	38x38x14
1151	16	100 1.000	0,3732	47x47x16
1156	16	5 500	0,4105	47x47x16
1152	18	100 1.000	0,3733	47x47x17
1153	20	100 1.000	0,3733	47x47x18



CODO CON TOMA GRAN CAUDAL SEGURIDAD
GREAT FLOW INTAKE ELBOW WITH SAFETY RING
COUDE DEPART GRAND DEBIT DE SÉCURITÉ
JOELHO TOMADA GRAN CAUDAL SEGURANÇA

Ref.	Ø (mm)		€	Dimensiones A-B-C
1291	16	100 1.000	0,5457	46x45x21



CODO ROSCA MACHO SEGURIDAD
MALE THREADED ELBOW WITH SAFETY RING
COUDE FILETÉ DE SÉCURITÉ
JOELHO RM SEGURANÇA

Ref.	Ø (mm - ")		€	Dimensiones A-B-C
1251	16 - 1/2	100 1.000	0,5226	47x39x20
1256	16 - 1/2	5 500	0,5748	47x39x20
1253	20 - 1/2	100 1.000	0,5226	47x46x18
1254	16 - 3/4	100 1.000	0,5457	46x40x25
1255	20 - 3/4	100 1.000	0,5457	48x50x26



TE SEGURIDAD
TEE WITH SAFETY RING
TE DE SÉCURITÉ
TE SEGURANÇA

Ref.	Ø (mm)			€	Dimensiones A-B-C
1170	12	100	1.000	0,2984	75x42x16
1171	16	100	1.000	0,3483	78x46x16
1176	16	5	500	0,3831	78x46x16
1172	18	50	1.000	0,5224	79x47x18
1173	20	50	1.000	0,3731	86x51x20



TE REDUCIDA SEGURIDAD
REDUCED TE WITH SAFETY RING
TE REDUIT DE SÉCURITÉ
TE REDUZIDA SEGURANÇA

Ref.	Ø (mm)			€	Dimensiones A-B-C
1180	16 - 12 - 16	50	1.000	0,3980	80x44x16
1181	20 - 16 - 20	50	1.000	0,4229	86x50x19
1182	16 - 20 - 16	50	1.000	0,4977	80x48x16



TE CON TOMA GRAN CAUDAL SEGURIDAD
TE GREAT FLOW INTAKE WITH SAFETY RING
TE DEPART GRAND DÉBIT DE SÉCURITÉ
TE TOMA GRAN CAUDAL SEGURANÇA

Ref.	Ø (mm)			€	Dimensiones A-B-C
1191	16	100	1.000	0,5457	79x45x19



TE ROSCA MACHO SEGURIDAD
MALE THREADED TE WITH SAFETY RING
TE FILETE DE SÉCURITÉ
TE RM SEGURANÇA

Ref.	Ø (mm - ")			€	Dimensiones A-B-C
1211	16 - 1/2	50	1.000	0,5226	80x43x20
1216	16 - 1/2	5	500	0,5748	80x43x20
1213	20 - 1/2	50	1.000	0,5226	87x47x20
1214	3/4 - 16	50	1.000	0,5457	80x39x25
1215	3/4 - 20	50	1.000	0,5457	86x43x26



UNIÓN ROSCA MACHO SEGURIDAD
MALE THREADED UNION WITH SAFETY RING
RACCORD FILETÉ DE SÉCURITÉ
URM SEGURANÇA

Ref.	Ø (mm - ")			€	Dimensiones A-B-C
1231	16 - 1/2	100	2.000	0,2903	49x19x19
1236	16 - 1/2	5	1.000	0,3301	49x19x19
1232	18 - 1/2	100	2.000	0,2903	44x20x20
1233	20 - 1/2	100	2.000	0,2903	48x22x22
1241	3/4 - 16	100	2.000	0,3223	52x27x27
1243	3/4 - 20	100	2.000	0,3223	52x27x27
1221	3/8 - 16	100	2.000	0,2903	46x19x19
1223	3/8 - 20	100	2.000	0,2903	45x19x19



UNIÓN ROSCA HEMBRA SEGURIDAD
THREADED FEMALE WITH SAFETY RING
RACCORD FEMELE TARAUDE DE SÉCURITÉ
URH SEGURANÇA

Ref.	Ø (mm - ")			€	Dimensiones A-B-C
1271	16 - 1/2	100	1.000	0,8130	46x30x30
1276	16 - 1/2	5	500	0,8943	46x30x30
1273	20 - 1/2	100	1.000	0,8130	45x29x29
1281	3/4 - 16	100	1.000	0,8707	48x34x34
1286	3/4 - 16	5	500	0,9578	48x34x34
1283	3/4 - 20	100	1.000	0,8707	48x34x34





CRUZ SEGURIDAD
CROSS WITH SAFETY RING
CROIX DE SÉCURITÉ
CRUZ SEGURANÇA

Ref.	Ø (mm)			€	Dimensiones A-B-C
1161	16 - 16 - 16 - 16	50	500	0,8187	75x75x16
1166	16 - 16 - 16 - 16	5	250	0,9006	75x75x16
1163	20 - 20 - 20 - 20	50	500	0,8187	74x74x20
1164	20 - 16 - 16 - 20	50	500	0,8187	75x75x20



CRUZ ROSCA MACHO SEGURIDAD
MALE THREADED CROSS WITH SAFETY RING
CROIX FILETÉ DE SÉCURITÉ
CRUZ RM SEGURANÇA

Ref.	Ø (mm - ")			€	Dimensiones A-B-C
1261	1/2 - 16 - 16 - 16	50	500	0,7816	74x75x20
1266	1/2 - 16 - 16 - 16	5	250	0,8598	74x75x20
1262	1/2 - 20 - 20 - 20	50	500	0,7816	75x74x20
1263	1/2 - 16 - 16 - 20	50	500	0,7816	75x74x20





8 435277 928115



8 435277 928122



8 435277 928139



8 435277 928214



8 435277 928313



8 435277 928412



8 435277 928610



8 435277 928719



8 435277 928818



8 435277 928825



ENLACE COMPRESIÓN
COMPRESSION UNION
RACCORD PAR COMPRESION
UNIAO COMPRESAO

Ref.	Ø (mm)			€	Dimensiones A-B-C
2811	16	50	1.000	0,6738	75x27x27
2812	20	50	500	0,9922	
2813	25	50	500	1,2568	



ENLACE COMPRESIÓN - CINTA SUPERROSCADA
COMPRESSION UNION - SUPER-THREADED TAPE UNION
RACCORD PAR COMPRESION - TUYAU PLAT SUPERROSCADA
UNIAO COMPRESSAO - FITA SUPERROSCADA

Ref.	Ø (mm)			€	Dimensiones A-B-C
2821	16	50	1.000	0,7858	76x27x27



TOMA GRAN CAUDAL COMPRESIÓN
COMPRESSION GREAT FLOW INTAKE
DÉPART GRAND DEBIT COMPRESSION
TOMA GRAN CAUDAL COMPRESSAO

Ref.	Ø (mm)			€	Dimensiones A-B-C
2831	16	100	1.000	0,5054	69x27x27



UNIÓN ROSCA MACHO COMPRESIÓN
MALE THREADED COMPRESSION UNION
RACCORD COMPRESSION MALE FILETÉ
UNIAO RM COMPRESSAO

Ref.	Ø (mm)			€	Dimensiones A-B-C
2841	16	100	1.000	0,5054	59x27x27



CODO COMPRESIÓN
COMPRESSION ELBOW
COUDE COMPRESSION
JOELHO COMPRESSAO

Ref.	Ø (mm)			€	Dimensiones A-B-C
2861	16	25	500	1,1579	56x56x27



TE COMPRESIÓN
COMPRESSION TEE
TE COMPRESSION
TE COMPRESSAO

Ref.	Ø (mm)			€	Dimensiones A-B-C
2871	16	25	500	1,4880	96x56x27
2881	16	25	500	1,4880	96x56x27
2882	16	25	500	1,4880	96x56x27



ENLACE CINTA SUPERROSCADA
SUPER-THREADED TAPE UNION
RACCORD PAR SUPER-FILETE TUYAU PLAT
UNIAO FITA SUPERROSCADA

Ref.	Ø (mm)			€	Dimensiones A-B-C
2711	16	50	1.000	0,5418	76x27x27



ENLACE CINTA SUPERROSCADA - MANGUERA
SUPER-THREADED TAPE UNION - HOSE UNION

RACCORD PAR TUYAU - TUYAU PLAT SUPERROSCADA
UNIAO MANGUEIRA - FITA SUPERROSCADA

Ref.	Ø (mm)			€	Dimensiones A-B-C
2721	16	100	1.000	0,4518	70x27x27



TOMA GRAN CAUDAL CINTA SUPERROSCADA
SUPER-THREADED TAPE UNION GREAT FLOW INTAKE
DÉPART GRAND DÉBIT SUPER-FILETE TUYAU PLAT
TOMA GRAN CAUDAL FITA SUPERROSCADA

Ref.	Ø (mm)			€	Dimensiones A-B-C
2731	16	100	1.000	0,4518	70x27x27



UNIÓN ROSCA MACHO CINTA SUPERROSCADA
MALE THREADED SUPER-THREADED TAPE UNION
RACCORD SUPER-FILETÉ TUYAU PLAT MALE FILETÉ
UNIAO RM FITA SUPERROSCADA

Ref.	Ø (mm)			€	Dimensiones A-B-C
2741	16	100	1.000	0,4601	59x27x27



CODO CINTA SUPERROSCADA
SUPER-THREADED TAPE UNION ELBOW
COUDE SUPER-FILETE TUYAU PLAT
JOELHO FITA SUPERROSCADA

Ref.	Ø (mm)			€	Dimensiones A-B-C
2761	16	25	500	1,0526	56x56x27



TE CINTA SUPERROSCADA
SUPER-THREADED TAPE UNION TEE
TE SUPER-FILETE TUYAU PLAT
TE FITA SUPERROSCADA

Ref.	Ø (mm)			€	Dimensiones A-B-C
2771	16	25	500	1,3528	96x56x27
2781	16	25	500	1,4880	96x56x27
2782	16	25	500	1,4880	96x56x27

UNIÓN CINTA EXTRA

Idóneo para unir cintas a un bajo coste. La espiral interna de la anilla mejora la sujeción.

EXTRA TAPE UNIÓN

Ideal for joining low cost tapes. The internal spiral of the ring improves the grip.



UNIÓN CINTA MEGAROSCADA

El mega-recorrido de la rosca, proporciona mayor presión de la cinta sobre el cuerpo del enlace

MEGA-THREADED TAPE UNION

The mega-stroke of the thread, provides greater pressure of the tape on the body of de link



UNIÓN SUPERROSCADA

Sujeción máxima, la tuerca comprime a la cinta ocn el cuerpo de la unión.

SUPER-THREADED UNION

Maximum fixing. The thread presses the tape with de union body





"Y" ACETAL MANGUERA 2 SALIDAS A CINTA ROSCADA
ACETAL "Y" HOSE UNION - 2 OUTPUTS THREADED UNION
"Y" EN ACETAL TUYAU - 2 RACCORDS FILETÉ TUYAU PLAT
"Y" ACETAL MANGUEIRA 2 SAIDAS A FITA ROSCADA

"Y" ACETAL MANGUERA 2 SALIDAS A CINTA EXTRA
ACETAL "Y" HOSE UNION - 2 OUTPUTS EXTRA UNION
"Y" EN ACETAL TUYAU - 2 RACCORDS EXTRA TUYAU PLAT
"Y" ACETAL MANGUEIRA 2 SAIDAS A FITA EXTRA

Ref.	Ø (mm)			€	Dimensiones A-B-C
3161	16 / 16 - 16	25	500	1.0255	73x68x27
3162	20 / 16 - 16	50	500	1.0255	75x71x27

Ref.	Ø (mm)			€	Dimensiones A-B-C
3171	16 / 16 - 16 - 16	50	500	0,8437	73x68x20
3172	20 / 16 - 16 - 16	50	500	0,8437	75x71x20



"Y" ACETAL TOMA GRAN CAUDAL 2 SALIDAS A CINTA ROSCADA
ACETAL "Y" GREAT FLOW INTAKE- 2 OUTPUTS THREADED UNION
"Y" EN ACETAL DEPART GRAND DEBIT - 2 RACCORDS FILETÉ TUYAU PLAT
"Y" ACETAL TOMA GRAN CAUDAL 2 SAIDAS A FITA ROSCADA

"Y" ACETAL TOMA GRAN CAUDAL 2 SALIDAS A CINTA EXTRA
ACETAL "Y" GREAT FLOW INTAKE- 2 OUTPUTS EXTRA UNION
"Y" EN ACETAL DEPART GRAND DEBIT - 2 RACCORDS EXTRA TUYAU PLAT
"Y" ACETAL TOMA GRAN CAUDAL 2 SAIDAS A FITA EXTRA

Ref.	Ø (mm)			€	Dimensiones A-B-C
3163	16	50	500	1.0255	68x67x26

Ref.	Ø (mm)			€	Dimensiones A-B-C
3173	16	50	500	0,8437	68x67x20



"Y" ACETAL ROSCA MACHO 2 SALIDAS A CINTA ROSCADA
ACETAL "Y" MALE THREADED - 2 OUTPUTS THREADED UNION
"Y" EN ACETAL MALE FILETÉ - 2 RACCORDS FILETÉ TUYAU PLAT
"Y" ACETAL RM 2 SAIDAS A FITA ROSCADA

"Y" ACETAL ROSCA MACHO 2 SALIDAS A CINTA EXTRA
ACETAL "Y" MALE THREADED - 2 OUTPUTS EXTRA UNION
"Y" EN ACETAL MALE FILETÉ - 2 RACCORDS EXTRA TUYAU PLAT
"Y" ACETAL RM 2 SAIDAS A FITA EXTRA

Ref.	Ø (" - mm)			€	Dimensiones A-B-C
3164	1/2 / 16 - 16	50	500	1.0255	63x65x26

Ref.	Ø (" - mm)			€	Dimensiones A-B-C
3174	1/2 / 16 - 16 - 16	50	500	0,8437	63x65x20



ENLACE CINTA EXTRA ACETAL
EXTRA TAPE UNION
RACCORD TUYAU PLAT EXTRA
UNIAO FITA EXTRA

ENLACE CINTA EXTRA - MANGUERA
EXTRA TAPE UNION - HOSE UNION
RACCORD PAR TUYAU PLAT EXTRA - TUYAU
UNIAO FITA EXTRA - MANGUEIRA

Ref.	Ø (mm)			€	Dimensiones A-B-C
3111	16	100	1.000	0,2222	64x20x20
3113	22	50	500	0,5788	83x30x30

Ref.	Ø (mm - mm)			€	Dimensiones A-B-C
3121	16	100	1.000	0,1944	68x21x21
3123	22 - 20	50	500	0,5325	75x30x30



TOMA GRAN CAUDAL CINTA EXTRA
EXTRA TAPE UNION GREAT FLOW INTAKE
DÉPART GRAND DEBIT EXTRA TUYAU PLAT
TOMA GRAN CAUDAL FITA EXTRA

CODO CINTA EXTRA
EXTRA TAPE UNION ELBOW
COUDE EXTRA TUYAU PLAT
JOELHO FITA EXTRA

Ref.	Ø (mm)			€	Dimensiones A-B-C
3131	16	100	2.000	0,1944	50x20x20
3133	22	50	500	0,5325	66x30x30

Ref.	Ø (")			€	Dimensiones A-B-C
3141	16	50	1.000	0,7408	50x50x21



TE CINTA EXTRA
EXTRA TAPE UNION TEE
TE EXTRA TUYAU PLAT
TE FITA EXTRA

Ref.	Ø (")			€	Dimensiones A-B-C
3151	16	50	1.000	0,7871	86x50x21





TE CINTA EXTRA (ROSCA M./TOMA)
EXTRA TAPE UNION TEE (THREADED/INTAKE)
TE EXTRA TUYAU PLAT (FILETÉ/DEPART)
TE FITA EXTRA (RM/TOMA)

Ref.	Ø (\" - mm)			€	Dimensiones A-B-C
3155	1/2 - 16	50	1.000	0,7871	85x48x21
3157	16	50	1.000	0,7871	85x44x21



CODO CINTA EXTRA (ROSCA M./TOMA)
EXTRA TAPE UNION ELBOW (THREADED/INTAKE)
COUDE EXTRA TUYAU PLAT (FILETÉ/DEPART)
JOELHO FITA EXTRA (RM/TOMA)

Ref.	Ø (\" - mm)			€	Dimensiones A-B-C
3145	1/2 - 16	50	1.000	0,7408	
3147	16	50	1.000	0,7408	49x43x21



**ENLACE 16 CINTA PPC
TAPE UNION 16**
RACCORD TUYAU PLAT 16
UNIAO FITA 16

Ref.	Ø (mm)			€	Dimensiones A-B-C
1407	16	100	2.000	0,2116€	



**ENLACE 16 CINTA - MANGUERA PPC
TAPE UNION - HOSE UNION 16**
RACCORD PAR TUYAU PLAT - TUYAU 16
UNIAO MANGUEIRA - FITA

Ref.	Ø (mm)			€	Dimensiones A-B-C
1408	16	100	2.000	0,2010€	0



**TOMA 16 CINTA PPC
TAPE UNION GREAT FLOW INTAKE 16**
DÉPART GRAND DÉBIT TUYAU PLAT 16
TOMA GRAN CAUDAL FITA

Ref.	Ø (mm)			€	Dimensiones A-B-C
1409	16	100	2.000	0,2010€	0



ENLACE CINTA MEGAROSCADA
MEGA-THREADED TAPE UNION
RACCORD PAR MEGA-FILETÉ TUYAU PLAT
UNIAO FITA MEGAROSCADA

Ref.	Ø (mm)			€	Dimensiones A-B-C
3311	16	50	1.000	0,4968	84x25x25



ENLACE CINTA MEGAROSCADA - MANGUERA
MEGA-THREADED TAPE UNION - HOSE UNION
RACCORD PAR MEGA-FILETÉ TUYAU PLAT - TUYAU
UNIAO MANGUEIRA - FITA MEGAROSCADA

Ref.	Ø (mm)			€	Dimensiones A-B-C
3321	16	100	1.000	0,4141	74x26x26



UNIÓN ROSCA MACHO CINTA ROSCADA
MALE THREADED TAPE UNION
RACCORD FILETÉ TUYAU PLAT MALE FILETÉ
UNIAO RM FITA ROSCADA

Ref.	Ø (" - mm)			€	Dimensiones A-B-C
1561	1/2 - 16	100	1.000	0,4408	51x27x27



TOMA GRAN CAUDAL CINTA MEGAROSCADA
MEGA-THREADED TAPE UNION GREAT FLOW INTAKE
DÉPART GRAND DÉBIT MEGA-FILETÉ TUYAU PLAT
TOMA GRAN CAUDAL FITA MEGAROSCADA

Ref.	Ø (mm)			€	Dimensiones A-B-C
3331	16	100	1.000	0,4141	65x26x26



TE CINTA MEGAROSCADA
THREADED TAPE UNION MEGA-THREADED
TE FILETE MEGA-FILETE
TE FITA MEGAROSCADA

Ref.	Ø (mm)			€	Dimensiones A-B-C
3335	16	25	500	1,2964	
3336	16 - 1/2	25	500	1,2964	
3337	16	25	500	1,2964	



CODO CINTA MEGAROSCADA
THREADED TAPE UNION MEGA-THREADED
COUDE FILETE MEGA-FILETE
JOELHO FITA MEGAROSCADA

Ref.	Ø (mm)			€	Dimensiones A-B-C
3325	16	25	500	1,0087	
3326	1/2 - 16	25	500	1,0087	
3327	16	25	500	1,0087	

ENLACE LAYFLAT
LAYFLAT UNION
RACCORD PAR LAYFLAT
UNIAO LAYFLAT

Ref.	Ø (mm)			€	Dimensiones A-B-C
3511	55	-	150	5.0935	
3512	63	-	90	6.3063	
3513	77	-	100	9.9445	
3514	102	-	45	11.8849	
(PVC) 3515	127	-	15	22.0500	

UNIÓN ROSCA MACHO LAYFLAT
MALE THREADED LAYFLAT UNION
RACCORD LAYFLAT MALE FILETÉ
UNIAO RM LAYFLAT

Ref.	Ø (mm - ")			€	Dimensiones A-B-C
3521	55 - 1 1/2	-	150	5.0935	
3522	63 - 2	-	100	6.3063	
3523	77 - 2 1/2	-	100	9.9445	
3524	102 - 3	-	50	11.8849	
(PVC) 3525	127 - 4	-	15	22.0500	

TAPÓN LAYFLAT
LAYFLAT PLUG
BOUCHON POUR LAYFLAT
TACO LAYFLAT

Ref.	Ø (mm)			€	Dimensiones A-B-C
3531	55	-	150	5.0935	
3532	63	-	100	6.3063	
3533	77	-	100	9.9445	
3534	102	-	50	11.8849	
(PVC) 3535	127	-	10	22.0500	

CODO LAYFLAT
LAYFLAT ELBOW
COUDE POUR LAYFLAT
JOELHO LAYFLAT

Ref.	Ø (mm)			€	Dimensiones A-B-C
3561	55	-	100	7.2765	
3562	63	-	50	8.4892	
3563	77	-	50	9.7020	
3564	102	-	25	12.1275	
(PVC) 3565	127	-	10	38.5875	



TE LAYFLAT
LAYFLAT TEE
TE POUR LAYFLAT
TE LAYFLAT

Ref.	Ø (mm)			€	Dimensiones A-B-C
3541	55	-	100	8,7318	
3542	63	-	50	9,9335	
3543	77	-	50	11.1573	
3544	102	-	15	15.5232	
(PVC) 3545	127	-	10	38.5875	



TE LAYFLAT ROSCA MACHO
LAYFLAT MALE THREADED TEE
TE FILETÉ POUR LAYFLAT
TE RM LAYFLAT

Ref.	Ø (mm - ")			€	Dimensiones A-B-C
3551	55 - 1 1/2	-	100	9,9445	
3552	63 - 2	-	50	10,9147	
3553	77 - 2 1/2	-	50	12.1275	
3554	102 - 3	-	25	16.9785	
(PVC) 3555	127 - 4	-	10	38.5875	



CODO LAYFLAT ROSCA MACHO
LAYFLAT MALE THREADED ELBOW
COUDE FILETÉ POUR LAYFLAT
JOELHO RM LAYFLAT

Ref.	Ø (mm - ")			€	Dimensiones A-B-C
3571	55 - 1 1/2	-	100	8.4892	
3572	63 - 2	-	50	9,7020	
3573	77 - 2 1/2	-	50	10,9147	
3574	102 - 3	-	25	13.3402	
(PVC) 3575	127 - 4	-	10	38.5875	



Ejemplo de utilización
Example of use



TOMA LAYFLAT MANGUERA
LAYFLAT INTAKE FOR HOSE
DÉPART LAYFLAT POUR TUYAU
UNIAO LAYFLAT MANGUEIRA

Ref.	Ø (mm)			€	Dimensiones A-B-C
1541	16	100	1.000	0,7033	53x38x27



TOMA LAYFLAT CINTA
LAYFLAT INTAKE FOR TAPE
DÉPART LAYFLAT POUR TUYAU PLAT
UNIAO LAYFLAT FITA

Ref.	Ø (mm)			€	Dimensiones A-B-C
1531	16	50	1.000	0,7033	Superroscada
1533	16	50	1.000	1,0672	Extra



TOMA LAYFLAT ROSCA HEMBRA
LAYFLAT INTAKE FOR MALE THREADED
DÉPART LAYFLAT POUR MALE THREADED
UNIAO LAYFLAT PARA RM

Ref.	Ø (")			€	Dimensiones A-B-C
1545	1/2	100	1.000	0,7033	43x27x27

Ejemplo de montaje
Assembly example

Ejemplo de combinaciones
Combinations example

- + = **3155**
- + = **3021**
- + = **1751**



LLAVES CLIPADAS PRESSED VALVES



**Cuerpo fabricado en Acetal
(Mayor resistencia)**
*Body made of Acetal (High
resistance)*



LLAVES TOTAL TOTAL VALVES



Sistema de fijación en golpes de ariete
No leak system



Alta estanqueidad (2 Juntas toricas)
High tightness (2 O-rings)

LLAVES EXTRA EXTRA VALVES



Sistema de fijación en golpes de ariete
No leak system



Maxima estanqueidad (4 Juntas toricas)
Maximum tightness (4 O-rings)





LLAVE TOTAL COMPRESIÓN
COMPRESSION TOTAL VALVE
VANNE TOTAL DE COMPRESSION
VALVULA TOTAL COMPRESSAO

Ref.	Ø (mm)			€	Dimensiones A-B-C
1841	16	50	700	1,5108	104x28x27



LLAVE TOTAL COMPRESIÓN - ROSCA MACHO
COMPRESSION TOTAL VALVE - MALE THREADED
VANNE TOTAL DE COMPRESSION - FILETÉ
VALVULA TOTAL COMPRESSAO - RM

Ref.	Ø (" - mm)			€	Dimensiones A-B-C
1746	1/2 - 16	50	700	1,3621	95x28x27



LLAVE TOTAL COMPRESIÓN - TOMA GRAN CAUDAL
COMPRESSION TOTAL VALVE - GREAT FLOW INTAKE
VANNE TOTAL DE COMPRESSION - DEPART GRAND DEBIT
VALVULA TOTAL COMPRESSAO - TOMA GRAN CAUDAL

Ref.	Ø (mm)			€	Dimensiones A-B-C
1851	16	50	700	1,3621	97x28x27



LLAVE TOTAL SIMPLE
SIMPLE TOTAL VALVE
VANNE TOTAL SIMPLE
VALVULA TOTAL SIMPLE

Ref.	Ø (mm)			€	Dimensiones A-B-C
1710	12	100	1.000	0,9660	77x28x11
1711	16	100	1.000	0,8270	76x28x15
1716	16	5	500	1.0406	76x28x15
1712	18	100	1.000	0,9986	75x28x16



LLAVE TOTAL SEGURIDAD
TOTAL VALVE WITH SAFETY RING
VANNE TOTAL DE SÉCURITÉ
VALVULA TOTAL SEGURANÇA

Ref.	Ø (mm)			€	Dimensiones A-B-C
1810	12	100	1.000	1,0707	73x28x9
1811	16	100	1.000	1,1194	77x28x13
1816	16	5	500	1,2315	77x28x13
1813	20	50	1.000	1,6674	77x28x17



LLAVE TOTAL SIMPLE - TOMA GRAN CAUDAL
SIMPLE TOTAL VALVE - GREAT FLOW INTAKE
VANNE TOTAL SIMPLE - DEPART GRAND DEBIT
VALVULA TOTAL SIMPLE - TOMA GRAN CAUDAL

Ref.	Ø (mm)			€	Dimensiones A-B-C
1761	16	100	1.000	1,0821	82x28x14
1762	18	100	1.000	1,0821	82x28x14



LLAVE TOTAL SIMPLE - ROSCA MACHO
SIMPLE TOTAL VALVE - MALE THREADED
VANNE TOTAL SIMPLE - FILETÉ
VALVULA TOTAL SIMPLE - RM

Ref.	Ø (" - mm)			€	Dimensiones A-B-C
1751	1/2 - 16	50	1.000	1,0821	81x28x14
1755	1/2	50	1.000	1,7073	



LLAVE TOTAL CINTA
TOTAL VALVE FOR TAPE
VANNE TOTAL POUR TUYAU PLAT
VALVULA TOTAL FITA

Ref.	Ø (mm)			€	Dimensiones A-B-C
1771	16	50	700	1,3736	112x28x21
1861	16	50	700	1,3736	89x28x26

LLAVE TOTAL CINTA - ROSCA MACHO
TOTAL VALVE FOR TAPE - MALE THREADED
VANNE TOTAL DE POUR TUYAU PLAT - FILETÉ
VALVULA TOTAL FITA - RM

Ref.	Ø (" - mm)			€	Dimensiones A-B-C
1726	1/2 - 16	50	700	1,2834	97x28x21
1736	1/2 - 16	50	700	1,2834	87x28x25



LLAVE TOTAL CINTA - MANGUERA
TOTAL VALVE FOR TAPE - HOSE
VANNE TOTAL POUR TUYAU PLAT - TUYAU
VALVULA TOTAL FITA - MANGUEIRA

Ref.	Ø (mm)			€	Dimensiones A-B-C
1781	16	50	700	1,2384	93x28x26
1881	16	50	700	1,2384	83x28x27

LLAVE TOTAL CINTA - TOMA GRAN CAUDAL
TOTAL VALVE FOR TAPE - GREAT FLOW INTAKE
VANNE TOTAL POUR TUYAU PLAT - DEPART GRAND DEBIT
VALVULA TOTAL FITA - TOMA GRAN CAUDAL

Ref.	Ø (mm)			€	Dimensiones A-B-C
1791	16	50	700	1,2384	101x28x26
1871	16	50	700	1,2384	84x28x26



LLAVE CLIPADA ACETAL Y TOMA GRAN CAUDAL
ACETAL PRESSED VALVE - GREAT FLOW INTAKE
VANNE PRESEE - DEPART GRAND DEBIT EN ACETAL
VALVULA PRESIONADA - TOMA GRAN CAUDAL ACETAL

LLAVE CLIPADA - ROSCA MACHO ACETAL
ACETAL PRESSED VALVE - MALE THREADED
VANNE PRESEE - FILETÉ EN ACETAL
VALVULA PRESIONADA - RM ACETAL

Ref.	Ø (mm)			€	Dimensiones A-B-C
2061	16	50	700	0,6391	
2062	20	50	700	0,6391	
2071	16	50	700	0,6391	
2072	20	50	700	0,6391	

Ref.	Ø (mm “)			€	Dimensiones A-B-C
2081	16 - 1/2	50	700	0,7029	
2082	20 - 1/2	50	700	0,7029	
2083	16 - 3/4	50	700	0,7029	
2084	20 - 3/4	50	700	0,7029	



LLAVE GOTEO
DRIP IRRIGATION VALVE
VANNE GOUTTE À GOUTTE
VALVULA GOTEJAMENTO

LLAVE GOTEO
DRIP IRRIGATION VALVE
VANNE GOUTTE À GOUTTE
VALVULA GOTEJAMENTO

Ref.	Ø (mm)			€	Dimensiones A-B-C
2106	25	100		9,0000	
2107	32	100		10,0000	

Ref.	Ø (mm)			€	Dimensiones A-B-C
2104	25	100		6,0000	
2105	32	100		6,0000	



LLAVE GOTEO
DRIP IRRIGATION VALVE
VANNE GOUTTE À GOUTTE
VALVULA GOTEJAMENTO

LLAVE GOTEO
DRIP IRRIGATION VALVE
VANNE GOUTTE À GOUTTE
VALVULA GOTEJAMENTO

Ref.	Ø (mm)			€	Dimensiones A-B-C
2102	25	100		6,0000	
2103	32	100		6,0000	

Ref.	Ø (mm)			€	Dimensiones A-B-C
2108	25	100		8,0000	
2109	32	100		9,0000	



LLAVE CLIPADA CINTA EXTRA EN ACETAL
ACETAL PRESSED VALVE FOR EXTRA TAPE
VANNE PRESSEE POUR TUYAU PLAT EXTRA ACETAL
VALVULA PRESIONADA FITA EXTRA ACETAL

Ref.	Ø (mm)			€	Dimensiones A-B-C
1951	16	50	700	1,2486	
1952	22	50	700	1,5655	



LLAVE CLIPADA CINTA EXTRA - MANGUERA ACETAL
ACETAL PRESSED VALVE FOR EXTRA TAPE - HOSE
VANNE PRESSEE POUR TUYAU PLAT EXTRA - TUYAU EN ACETAL
VALVULA PRESIONADA FITA EXTRA - MANGUEIRA ACETAL

Ref.	Ø (mm - mm)			€	Dimensiones A-B-C
1961	16 - 16	50	700	1,1258	
1962	22 - 20	50	700	1,5655	



LLAVE CLIPADA CINTA EXTRA - TOMA GRAN CAUDAL ACETAL
ACETAL PRESSED VALVE FOR EXTRA TAPE - GREAT FLOW INTAKE
VANNE PRESSEE POUR TUYAU PLAT EXTRA - GRAND DEBIT EN ACETAL
VALVULA PRESIONADA FITA EXTRA - TOMA GRAN CAUDAL ACETAL

Ref.	Ø (mm)			€	Dimensiones A-B-C
1971	16	50	700	1,1258	
1972	22	50	700	1,5655	



LLAVE CLIPADA CINTA EXTRA - ROSCA MACHO ACETAL
ACETAL PRESSED VALVE FOR EXTRA TAPE - MALE THREADED
VANNE PRESSEE POUR TUYAU PLAT EXTRA - FILETÉ EN ACETAL
VALVULA PRESIONADA FITA EXTRA - RM ACETAL

Ref.	Ø (" - mm)			€	Dimensiones A-B-C
1981	1/2 - 16	50	700	1,0804	
1982	1/2 - 22	50	700	1,5655	
1983	3/4 - 16	50	700	1,0804	
1984	3/4 - 22	50	700	1,5655	



**LLAVE EXTRA CINTA MEGARROSCADA
EXTRA VALVE FOR MEGA-THREADED TAPE**

**LLAVE EXTRA CINTA MEGARROSCADA- MANGUERA
EXTRA VALVE FOR MEGA-THREADED TAPE - HOSE**

VANNE EXTRA POUR TUYAU PLAT MEGA-FILETÉ

VANNE EXTRA POUR TUYAU PLAT MEGA-FILETÉ - TUYAU

VALVULA EXTRA FITA MEGARROSCADA

VALVULA EXTRA FITA MEGARROSCADA - MANGUEIRA

Ref.	Ø (mm)			€	Dimensiones A-B-C
3410	16	50	700	1,3736	89x39x26
3411	16	50	700	1,3736	89x50x26
3412	16	50	700	1,3736	89x44x26
3413	16	50	700	1,3736	89x53x26

Ref.	Ø (mm)			€	Dimensiones A-B-C
3420	16	50	700	1,2383	89x39x26
3421	16	50	700	1,2383	89x50x26
3422	16	50	700	1,2383	89x44x26
3423	16	50	700	1,2383	89x53x26



**LLAVE EXTRA CINTA MEGARROSCADA - TOMA GRAN CAUDAL
EXTRA VALVE FOR MEGA-THREADED TAPE - GREAT FLOW INTAKE**

**LLAVE EXTRA CINTA MEGARROSCADA - ROSCA MACHO
EXTRA VALVE FOR MEGA-THREADED TAPE - MALE THREADED**

VANNE EXTRA POUR TUYAU PLAT MEGA-FILETÉ - DEPART GRAND DEBIT

VANNE EXTRA POUR TUYAU PLAT MEGA-FILETÉ - FILETÉ

VALVULA EXTRA FITA MEGARROSCADA - TOMA GRAN CAUDAL

VALVULA EXTRA FITA MEGARROSCADA - RM

Ref.	Ø (mm)			€	Dimensiones A-B-C
3430	16	50	700	1,2383	89x39x26
3431	16	50	700	1,2383	89x50x26
3432	16	50	700	1,2383	89x44x26
3433	16	50	700	1,2383	89x53x26

Ref.	Ø (" - mm)			€	Dimensiones A-B-C
3440	1/2 - 16	50	700	1,2383	89x39x26
3441	1/2 - 16	50	700	1,2383	89x50x26
3442	1/2 - 16	50	700	1,2383	89x44x26
3443	1/2 - 16	50	700	1,2383	89x53x26



**LLAVE EXTRA CINTA ROSCADA
EXTRA VALVE FOR THREADED TAPE
VANNE EXTRA POUR TUYAU PLAT FILETÉ
VALVULA EXTRA FITA ROSCADA**

Ref.	Ø (mm)			€	Dimensiones A-B-C
2955	16	50	700	1,3736	81x39x26
2965	16	50	700	1,3736	81x44x26
2975	16	50	700	1,3736	81x53x26
2985	16	50	700	1,3736	81x50x26



**LLAVE EXTRA CINTA ROSCADA - MANGUERA
EXTRA VALVE FOR THREADED TAPE - HOSE
VANNE EXTRA POUR TUYAU PLAT FILETÉ - TUYAU
VALVULA EXTRA FITA ROSCADA - MANGUEIRA**

Ref.	Ø (mm)			€	Dimensiones A-B-C
2957	16	50	700	1,2384	81x39x15
2967	16	50	700	1,2384	81x44x15
2977	16	50	700	1,2384	81x53x15
2987	16	50	700	1,2384	81x50x15



**LLAVE EXTRA CINTA ROSCADA - TOMA GRAN CAUDAL
EXTRA VALVE FOR THREADED TAPE - GREAT FLOW INTAKE
VANNE EXTRA POUR TUYAU PLAT FILETÉ - DEPART GRAND DEBIT
VALVULA EXTRA FITA ROSCADA - TOMA GRAN CAUDAL**

Ref.	Ø (mm)			€	Dimensiones A-B-C
2959	16	50	700	1,2384	81x39x14
2969	16	50	700	1,2384	81x44x14
2979	16	50	700	1,2384	81x53x14
2989	16	50	700	1,2384	81x50x14



***La tuerca de fijación permite fijar la llave y evitar escapes. Una vez introducida la toma, desenroscamos la tuerca permitiendo que quede apretada contra el tubo.**

**The fixing nut allows to fix the key and avoid leaks. Once the is inserted, we unscrew the nut allowing it to be pressed against the tube.*



**LLAVE EXTRA SIMPLE
SIMPLE EXTRA VALVE
VANNE EXTRA SIMPLE
VALVULA EXTRA SIMPLE**

Ref.	Ø (mm)	📦	📦	€	Dimensiones A-B-C
2911	16	50	1.000	0,8270	81x39x15
2913	20	50	1.000	0,8270	81x39x19
2915	16	50	1.000	1.0217	81x44x15
2921	16	50	1.000	0,8270	81x44x15
2923	20	50	1.000	0,8270	81x44x19
2931	16	50	1.000	0,8270	81x53x15
2933	20	50	1.000	0,8270	81x53x19
2941	16	50	1.000	0,8270	81x50x15
2943	20	50	1.000	0,8270	81x50x19



**LLAVE EXTRA SIMPLE - TOMA GRAN CAUDAL
SIMPLE EXTRA VALVE - GREAT FLOW INTAKE
VANNE EXTRA SIMPLE - DEPART GRAND DEBIT
VALVULA EXTRA SIMPLE - TOMA GRAN CAUDAL**

Ref.	Ø (mm)	📦	📦	€	Dimensiones A-B-C
2916	16	50	1.000	0,8270	80x39x14
2918	20	50	1.000	0,8270	80x39x14
2926	16	50	1.000	0,8270	80x44x14
2928	20	50	1.000	0,8270	80x44x14
2936	16	50	1.000	0,8270	80x53x14
2938	20	50	1.000	0,8270	80x53x14
2946	16	50	1.000	0,8270	80x50x14
2948	20	50	1.000	0,8270	80x50x14



**LLAVE EXTRA CINTA MEGAROSCADA - TOMA TUERCA FIJACIÓN
EXTRA VALVE FOR MEGA-THREADED TAPE - NUT FIXING INTAKE**

VANNE EXTRA POUR TUYAU PLAT MEGA-FILÉTÉ - DEPART ECROU DE FIXATION

VALVULA EXTRA FITA MEGAROSCADA - TOMA PORCA FIXA

Ref.	Ø (mm)	📦	📦	€	Dimensiones A-B-C
1789	16	50	700	1,3736	90x48x24



**LLAVE EXTRA SIMPLE - ROSCA MACHO
SIMPLE EXTRA VALVE - MALE THREADED**

VANNE EXTRA SIMPLE - FILETÉ

VALVULA EXTRA SIMPLE - RM

Ref.	Ø (" - mm)	📦	📦	€	Dimensiones A-B-C
2951	1/2 - 16	50	1.000	1.0471	79x39x23
2953	1/2 - 20	50	1.000	1.0471	79x39x23
2961	1/2 - 16	50	1.000	1.0471	79x44x23
2963	1/2 - 20	50	1.000	1.0471	74x44x23
2971	1/2 - 16	50	1.000	1.0471	79x53x23
2973	1/2 - 20	50	1.000	1.0471	79x53x23
2981	1/2 - 16	50	1.000	1.0471	79x50x23
2983	1/2 - 20	50	1.000	1.0471	79x50x23



TAPÓN ASA SIMPLE
HANDLED SIMPLE PLUG
BOUCHON SIMPLE AVEC ANNEAU
TAMPAO ASA SIMPLES

Ref.	Ø (mm)			€	Dimensiones A-B-C
1310	12	100	3.000	0,0696	30x14x14
1311	16	100	3.000	0,0876	46x15x15
1313	20	100	3.000	0,0876	48x18x18

TAPÓN ASA ACETAL
HANDLED ACETAL PLUG
BOUCHON ACETAL AVEC ANNEAU
TAMPAO ASA ACETAL

Ref.	Ø (mm)			€	Dimensiones A-B-C
1320	12	100	3.000	0,0788	38x14x10
1321	16	100	3.000	0,0992	41x16x16
1326	16	10	1.500	0,1191	41x16x16

ESTRANGULADOR FINAL
END LINE CHOKE
ESTRANGLEURS
ANEL FIM LINHA

Ref.	Ø (mm)			€	Dimensiones A-B-C
1350	12	100	3.000	0,0696	32x17x16
1351	16	100	3.000	0,0798	39x17x19
1356	16	10	1.500	0,0958	39x17x19
1353	20	100	1.500	0,0798	51x17x25

TAPÓN COMPRESIÓN
COMPRESION PLUG
BOUCHON COMPRESSION
TACO COMPRESSAO

Ref.	Ø (mm)			€	Dimensiones A-B-C
2851	16	100	1.000	0,5054	43x27x21

1340
1341



1343
1344



**TAPÓN MIXTO
MIXED PLUG
BOUCHON MIXTE
TACO MISTO OCO**

Ref.	Ø (mm)			€	Dimensiones A-B-C
1340	12 - 15 - 16	100	3.000	0,0696	26x15x15 Hueco
1341	16 - 18	100	3.000	0,1913	26x18x18 Hueco
1343	12 - 15 - 16	100	3.000	0,0847	25x15x15 Macizo
1344	16 - 18	100	3.000	0,2296	26x18x18 Macizo

**TAPÓN PINCHADO CON AGUJERO
INSERTED PLUGS WITH AN ORIFICE
BOUCHON PERFORE
TACO POR ORIFICIOS**

Ref.	Ø (mm)			€	Dimensiones A-B-C
1330	3x3	1.000	10.000	0,0368	10x5x5
1331	4x4	1.000	10.000	0,0368	12x7x7
1332	5x5	1.000	10.000	0,0368	12x8x8
1337	5x5	50	5.000	0,1161	12x8x8
1333	6x6	1.000	10.000	0,0476	12x8x8
1334	Toma Normal	1.000	10.000	0,0637	13x14x14
1335	Toma Gran Caudal	1.000	10.000	0,0795	14x15x15

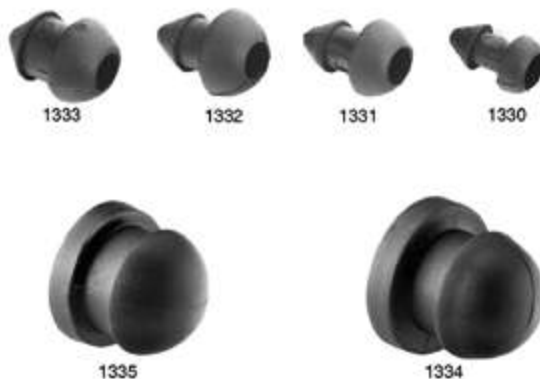

2751

**TAPÓN CINTA SUPERROSCADA
THREADED AND SUPER-THREADED TAPE PLUG
BOUCHON TUYAU PLAT FILETÉ ET SUPER-FILETÉ
TACO FITA ROSCADA Y SUPER-ROSCADA**

Ref.	Ø (mm)			€	Dimensiones A-B-C
1551	16	100	1.000	0,4405	47x26x22
2751	16	100	1.000	0,4596	47x26x22



3181
3183



3381

**TAPÓN CINTA MEGA-ROSCADA Y EXTRA
MEGA-THREADED AND EXTRA TAPE PLUG
BOUCHON TUYAU PLAT MEGA-FILETÉ ET EXTRA
TACO FITA MEGAROSCADA Y EXTRA**

Ref.	Ø (mm)			€	Dimensiones A-B-C
3181	16	100	1.000	0,1944	59x19x24
3183	22	50	1.000	0,5325	67x30x30
3381	16	100	1.000	0,4212	65x25x25



GOTERO REGULABLE
ADJUSTABLE DRIPPER
GOUTTEUR REGLABLE
GOTEJADOR REGULAVEL CRAVAR

Ref.	Cap (l/h)			€	Dimensiones A-B-C
2112	0-6	500	10.000	0,1085	31x7x7
2117	0-6	25	5.000	0,1183	31x7x7



GOTERO LAGO
DRIPPER LAGO
GOUTTEUR LAGO
GOTEJADOR PINCHADO LAGO

Ref.	Cap (l/h)			€	Dimensiones A-B-C
2140	5	200	4.000	0,1505	37x15x17
2141	5	200	4.000	0,2219	37x17x17
2146	5	25	2.000	0,2663	37x17x17



GOTERO INTERLÍNEA
INTERLINEAL DRIPPER
GOUTTEUR INTERLIGNE
GOTEJADOR INTERLINHA

Ref.	Ø (mm)			€	Dimensiones A-B-C
2160	12	100	5.000	0,0519	60x14x11
2161	16	100	2.500	0,0994	77x17x16
2163	-	-	1.000	0,2728	



GOTERO LANZA MIXTA
MIX SPEAR DRIPPER
GOUTTEUR PIEU MIXTE
GOTEJADOR LANÇA MIXTA

Ref.	Ø (mm)			€	Dimensiones A-B-C
2150	2x3 a 3x4,5	-	5.000	0,0439	113x1x2
2151	6,5x4,5	-	5.000	0,0703	113x4x11



GOTERO REGULABLE GRAN CAUDAL
GREAT FLOW ADJUSTABLE DRIPPER
GOUTTEUR REGLABLE GRAND DEBIT
GOTEJADOR REGULAVEL

Ref.	Cap (l/h)			€	Dimensiones A-B-C
2110	0 - 70	100	5.000	0,1104	25x24x15
2114	0 - 70	100	5.000	0,1104	24x23x14
2115	0 - 70	25	2.500	0,1383	24x23x14



GOTERO REGULABLE GRAN CAUDAL CON ESTACA
GREAT FLOW ADJUSTABLE DRIPPER STAKE MOUNTED
GOUTTEUR REGLABLE GRAND DEBIT AVEC PIEU
GOTEJADOR REGULAVEL CON ESTACA

Ref.	Cap (l/h)			€	Dimensiones A-B-C
2192	0 - 40	-	1.000	0,2377	145x28x14
2111	0 - 70	-	1.000	0,2300	145x28x14
2116	0 - 70	-	1.000	0,2300	145x28x14
2193	0 - 100	-	250	0,4318	410x24x31



GOTERO REGULABLE GRAN CAUDAL
GREAT FLOW ADJUSTABLE DRIPPER
GOUTTEUR REGLABLE GRAND DEBIT
GOTEJADOR REGULAVEL

Ref.	Cap (l/h)			€	Dimensiones A-B-C
2190	0 - 40	100	5.000	0,1261	25x24x15
2191	0-100	100	5.000	0,2668	21X38X21



PRODUCTO REGISTRADO
PROTECTOR DE GOTEROS
PROTECTOR DRIPPER
PROTECTOR DE GOUTTEUR
PROTECTOR DE GOTEJADOR

Ref.	Cap (l/h)			€	Dimensiones A-B-C
2198			400	0,8100	185X55

Esta pieza está diseñada para proteger el gotero en las labores de trabajo.
Tiene cabidas para dos tipos de manguera de 20 y de 16.
La tapadera inicialmente es roja pero la podemos hacer azul en caso que la tierra pueda crear confusión.



GOTERO AUTOCOMPENSANTE DESMONTABLE LAGO
REMOVABLE AUTO-COMPENSATE DRIPPER LAGO
GOUTTEUR AUTO-COMPENSANT DEMONTABLE LAGO
GOTEJADOR REMOVÍVEL AUTOCOMPENSÁVEL LAGO

Ref.	Cap (l/h)			€	Dimensiones A-B-C
2122	2	200	4.000	0,2819	31x38x22
2120	4	200	4.000	0,2819	32x37x23
2125	4	25	2.000	0,4062	32x37x23
2121	8	200	4.000	0,2819	31x38x23
2126	8	25	2.000	0,4062	31x38x23



GOTERO AUTOCOMPENSANTE CLIPADO LAGO
AUTO-COMPENSATE DRIPPER LAGO
GOUTTEUR AUTO-COMPENSANT LAGO
GOTEJADOR AUTOCOMPENSÁVEL LAGO

Ref.	Cap (l/h)			€	Dimensiones A-B-C
2170	2	200	4.000	0,2541	23x17x5
2171	4	200	4.000	0,2541	23x17x5
2172	8	200	4.000	0,2541	23x17x5



GOTERO LABERINTO LAGO
LABYRINT DRIPPER LAGO
GOUTTEUR LABYRINTHE LAGO
GOTEJADOR LABIRINTO LAGO

Ref.	Cap (l/h)			€	Dimensiones A-B-C
2130	-	200	4.000	0,1981	31x38x23
2135	-	25	2.000	0,2377	31x38x23



ACOPLE GOTERO Y MICROTUBO
UNION FOR DRIPPER AND MICRO-HOSE
RACCORD GOUTTEUR ET MICROTUBE
ACOPLAMIENTO GOTERO E MICROTUBO

Ref.	(Ø (mm)) - Salidas			€	Dimensiones A-B-C
2240	(4,5x6,5) - 1	1.000	10.000	0,0808	14x7x7
2241	(4,5x6,5) - 2	1.000	10.000	0,1367	14x24
2242	(4,5x6,5) - 4	1.000	10.000	0,1975	14x24x24
2243	(5x3) - 1	1.000	10.000	0,0808	14x7x7
2244	(5x3) - 2	1.000	10.000	0,1367	14x24
2245	(5x3) - 4	1.000	10.000	0,1975	14x24x24



PIQUETA RECTA MICROTUBO
MICRO-HOSE STRAIGHT STAKE
PIEU DROIT MICROTUBE
ESTACA RETA MICROTUBO

PIQUETA CURVA MICROTUBO
MICRO-HOSE BENT STAKE
PIEU COURBÉ MICROTUBE
ESTACA CURVA MICROTUBO

Ref.	Ø (mm)			€	Dimensiones A-B-C
2210	4,5x6,5	-	3.000	0,0631	142x12x12
2211	5x3	-	3.000	0,0631	142x12x12
2230	Laberinto 4,5x6,5	-	3.000	0,0631	151x12x12
2222	Paso lateral 4,5x6,5	-	3.000	0,0693	142x12x12
2224	Abrazadera 4,5x6,5	-	3.000	0,0693	142x12x12
2113	8-20 (l/h)	-	1.000	0,2029	144x12x12

Ref.	Cap (l/h)			€	Dimensiones A-B-C
2220	4,5x6,5	-	3.000	0,0694	139x12x17
2221	5x3	-	3.000	0,0694	139x12x17
2231	Laberinto 4,5x6,5	-	3.000	0,0694	139x12x17
2223	Paso lateral 4,5x6,5	-	3.000	0,0694	139x12x17
2225	Abrazadera 4,5x6,5	-	3.000	0,0693	139x12x17



GANCHO COLGAR MANGUERA
HOOK FOR PIPING
CROCHET POUR TUYAU
GANCHO SUPORTE TUBO

Ref.	Ø (mm) (cm)			€	Dimensiones A-B-C	
2410	16-20	3	-	5.000	0,0940	36x22x14
2411	16-20	9	-	2.000	0,1614	94x22x14
2412	16-20	16	-	2.000	0,1766	160x32x6



PIQUETA SUJECCIÓN
MICRO-HOSE HOLDER STAKE
PIEU POUR MICROTUBE
ESTACA SUPORTE MICROTUBO

Ref.	Ø (mm)			€	Dimensiones A-B-C
2420	1 a 6	-	5.000	0,0774	118x13x5
2421	Sujeción dentada	-	3.000	0,1040	118x13x5
2430	12	-	5.000	0,0552	118x15x5
2431	16	-	-	0,0967	118x20x5



GOMAS Y MOSQUETÓN
RUBBER BANDS AND CARABINER
ELASTIQUES ET MOUSQUETON
ELASTICOS E MOSQUETÃO

Ref.	Ø (mm)			€	Dimensiones A-B-C
2453	19,5	200	4.000	0,0900	195x16x2
2450	5,5	200	4.000	0,1900	56,11x33,3x10,23
2456	12	200	4.000	0,0900	117x25x3,62



ESTACA GUÍA MANGUERA
PIPING GUIDE STAKE
PIEU GUIDE TUYAU
ESTACA GUIA MANGUERA

Ref.	Ø (mm)			€	Dimensiones A-B-C
2440	16 - 20	-	500	0,3041	190x25x19
2441	25 - 32	-	500	0,3596	200x35x19
2442	16 - 20 Garrote	-	500	0,3596	190x46x19
2443	● 16 - 20 Garrote Plano	-	1.000	0,1940	165x30x19
2444	● 16 - 20 Garrote Plano	-	1.000	0,2025	165x30x19



ACCESORIOS DE PRESIÓN PRESSURE ACCESSOIRES



ACCESSOIRES POUR PRESION
ACCESORIOS DE PREÇÃO

- 8 435277 940100
- 8 435277 940117
- 8 435277 940124
- 8 435277 940131
- 8 435277 940148
- 8 435277 940155
- 8 435277 940162
- 8 435277 940179
- 8 435277 940186
- 8 435277 940193
- 8 435277 940209
- 8 435277 940216
- 8 435277 940223
- 8 435277 940230
- 8 435277 940247
- 8 435277 940254
- 8 435277 940261
- 8 435277 940278
- 8 435277 940285
- 8 435277 940292
- 8 435277 940308
- 8 435277 940315
- 8 435277 940322
- 8 435277 940605



COLLARÍN TOMA 2 TORNILLOS
2 BOLTS SADDLE CLAMP
COLLIER DE PRISE 2 VISSES
TOMADA DE CARGA 2 PARAFUSOS

Ref.	Ø (mm-")			€	Ref. Doble	€
4010	25 - 1/2	1	100	1,9675	4110	3.0683
4011	25 - 3/4	1	100	1,9675	4111	3.0683
4012	32 - 1/2	1	100	2,3528	4112	3,6599
4013	32 - 3/4	1	100	2,3528	4113	3,6599
4014	32 - 1	1	100	2,3528	4114	3,6599
4015	40 - 1/2	1	100	2,7243	4115	4,2515
4016	40 - 3/4	1	100	2,7243	4116	4,2515
4017	40 - 1	1	100	2,7243	4117	4,2515
4018	50 - 1/2	1	50	3,2608	4118	5.0771
4019	50 - 3/4	1	50	3,2608	4119	5.0771
4020	50 - 1	1	50	3,2608	4120	5.0771
4021	50 - 1 1/4	1	50	3,2608	4121	5.0771

Collarín doble se sirve bajo pedido
Double saddle clamp delivered by order



COLLARÍN TOMA 4 TORNILLOS
4 BOLTS SADDLE CLAMP
COLLIER DE PRISE 4 VISSES
TOMADA DE CARGA 4 PARAFUSOS

Ref.	Ø (mm-")			€	Ref. Doble	€
4022	63 - 1/2	1	50	4,4304	4122	6,9208
4023	63 - 3/4	1	50	4,4304	4123	6,9208
4024	63 - 1	1	50	4,4304	4124	6,9208
4025	63 - 1 1/4	1	50	4,4304	4125	6,9208
4026	63 - 1 1/2	1	50	4,4304	4126	6,9208
4027	75 - 1/2	1	50	6,4806	4127	10.1131
4028	75 - 3/4	1	50	6,4806	4128	10.1131
4029	75 - 1	1	50	6,4806	4129	10.1131
4030	75 - 1 1/4	1	50	6,4806	4130	10.1131
4031	75 - 1 1/2	1	50	6,4806	4131	10.1131
4032	75 - 2	1	50	6,4806	4132	10.1131

Collarín doble se sirve bajo pedido.
Double saddle clamp delivered by order

COLLARÍN TOMA Y COLLARÍN TOMA DOBLE SADDLE CLAMP AND DOUBLE SADDLE CLAMP



COLLARÍN TOMA 4 TORNILLOS
4 BOLTS SADDLE CLAMP
COLLIER DE PRISE 4 VISES
TOMADA DE CARGA 4 PARAFUSOS

Ref.	Ø (mm-")			€	Ref. Doble	€
4033	90 - 1/2	1	25	7,5538	4133	11.7778
4034	90 - 3/4	1	25	7,5538	4134	11.7778
4035	90 - 1	1	25	7,5538	4135	11.7778
4036	90 - 1 1/4	1	25	7,5538	4136	11.7778
4037	90 - 1 1/2	1	25	7,5538	4137	11.7778
4038	90 - 2	1	25	7,5538	4138	11.7778
4039	110 - 1/2	1	20	8.2142	4139	12.8235
4040	110 - 3/4	1	20	8.2142	4140	12.8235
4041	110 - 1	1	20	8.2142	4141	12.8235
4042	110 - 1 1/4	1	20	8.2142	4142	12.8235
4043	110 - 1 1/2	1	20	8.2142	4143	12.8235
4044	110 - 2	1	20	8.2142	4144	12.8235
4045	125 - 1	-	20	11.4613	4145	17.8732
4046	125 - 1 1/4	-	20	11.4613	4146	17.8732
4047	125 - 1 1/2	-	20	11.4613	4147	17.8732
4048	125 - 2	-	20	11.4613	4148	17.8732

Collarín doble se sirve bajo pedido
Double saddle clamp delivered by order

COLLARÍN TOMA 6 TORNILLOS
6 BOLTS SADDLE CLAMP
COLLIER DE PRISE 6 VISES
TOMADA DE CARGA 6 PARAFUSOS

Ref.	Ø (mm-")			€	Ref. Doble	€
4049	140 - 1	-	15	21.2304	4149	33.1321
4050	140 - 1 1/4	-	15	21.2304	4150	33.1321
4051	140 - 1 1/2	-	15	21.2304	4151	33.1321
4052	140 - 2	-	15	21.2304	4152	33.1321
4053	160 - 1/2	-	15	21.2304	4153	33.1321
4054	160 - 1	-	15	21.2304	4154	33.1321
4055	160 - 1 1/4	-	15	21.2304	4155	33.1321
4056	160 - 1 1/2	-	15	21.2304	4156	33.1321
4057	160 - 2	-	15	21.2304	4157	33.1321
4058	200 - 2	-	6	45.2127	4158	70.5297
4059	200 - 2 1/2	-	6	45.2127	4159	70.5297
4060	200 - 3	-	6	45.2127	4160	70.5297

Collarín doble se sirve bajo pedido
Double saddle clamp delivered by order



PRESSURE
PRESIÓN



MANGUITO ENCOLAR PVC
PVC UNION TO GLUE
RACCORD PVC A COLLER
UNIAO PVC COLAR

Ref.	Ø (mm)			€
5011	20	-	200	0,5423
5012	25	-	200	0,6558
5013	32	-	100	0,8072
5014	40	-	100	1,1855
5015	50	-	50	1,4504
5016	63	-	50	2,3207
5017	75	-	35	4,9715
5018	90	-	25	5,2963
5019	110	-	25	5,2963



MANGUITO MIXTO PVC
PVC UNION MIXED
RACCORD PVC MIXTE
UNIAO PVC MIXTA

Ref.	Ø (mm - ")			€
5021	20 - 1/2	-	200	0,8955
5022	25 - 3/4	-	200	1,0090
5023	32 - 1	-	100	1,2108
5024	40 - 1 1/4	-	100	1,7657
5025	50 - 1 1/2	-	50	2,5729
5026	63 - 2	-	50	3,3044
5027	75 - 2 1/2	-	35	8,3441
5028	90 - 3	-	25	11,6917
5029	110 - 4	-	25	18,3623



TAPÓN ENCOLAR PVC
PVC PLUG TO GLUE
BOUCHON PVC A COLLER
TACO PVC COLAR

Ref.	Ø (mm)			€
5031	20	-	200	0,5045
5032	25	-	200	0,5297
5033	32	-	100	0,8072
5034	40	-	100	1,1603
5035	50	-	50	1,5891
5036	63	-	50	2,1820
5037	75	-	50	4,5468
5038	90	-	35	5,6210
5039	110	-	25	12,6411



CODO PVC HEMBRA A ENCOLAR
PVC ELBOW TO GLUE
COUDE PVC A COLLER
JOELHO PVC F/F COLAR

Ref.	Ø (mm)			€
5111	20	-	100	0,5297
5112	25	-	100	0,7441
5113	32	-	100	1,0720
5114	40	-	80	1,6143
5115	50	-	40	2,0179
A 8115	50 PN10	-	100	1,3600
5116	63	-	40	3,3297
5117	75	-	25	5,7960
5118	90	-	25	9,5933
5119	110	-	15	16,6882



CODO PVC HEMBRA A ENCOLAR - R/HEMBRA
FEMALE THREADED PVC ELBOW TO GLUE
COUDE PVC TARAUDE ET A COLLER
JOELHO PVC F. ROSCA - F.COLAR

Ref.	Ø (mm)			€
5121	20 - 1/2	-	100	1,1855
5122	25 - 3/4	-	100	1,2612
5123	32 - 1	-	100	2,0179
5124	40 - 1 1/4	-	80	2,5225
5125	50 - 1 1/2	-	40	3,0270
5126	63 - 2	-	40	5,4234
5127	75 - 2 1/2	-	25	16,6882
5128	90 - 3	-	25	26,1568
5129	110 - 4	-	15	40,0721



TERMINAL ROSCA MACHO

Ref.	Ø (mm)			€
8151	50 - 1/2	-	100	
8152	63 - 2"	-	100	

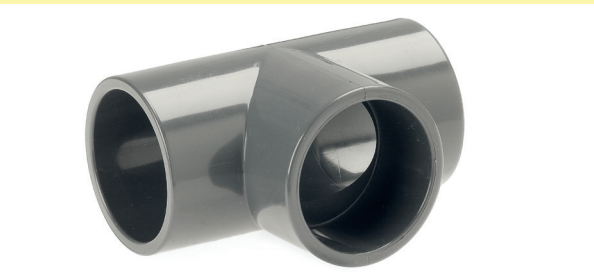

TE PVC HEMBRA A ENCOLAR
PVC TEE TO GLUE
TE PVC A COLLER
TE PVC F/F COLAR

Ref.	Ø (mm)			€	Dimensiones A-B-C
5131	20	-	100	0,6937	
5132	25	-	100	0,9585	
5133	32	-	100	1,3369	
5134	40	-	80	2,1189	
5135	50	-	40	2,9009	
8135	50 PN10	-	80	1,9000	
5136	63	-	40	4,2252	
5137	75	-	25	7,7196	
5138	90	-	25	12,5911	
5139	110	-	15	21,7848	



TE PVC HEMBRA A ENCOLAR - R/HEMBRA
FEMALE THREADED PVC TEE TO GLUE
TE PVC TARAUDE ET A COLLER

Ref.	Ø (mm)			€	Dimensiones A-B-C
5141	20 - 1/2	-	100	1,8161	
5142	25 - 3/4	-	100	1,9927	
5143	32 - 1	-	100	2,6234	
5144	40 - 1 1/4	-	80	3,9855	
5145	50 - 1 1/2	-	40	5,8017	
5146	63 - 2	-	40	7,3909	
5147	75 - 2 1/2	-	25	19,4864	
5148	90 - 3	-	25	28,9548	
5149	110 - 4	-	15	51,7271	



VÁLVULA PVC ENCOLAR ASIENTO PTFE
PVC BALL VALVE TO GLUE WITH PTFE JOINT
VANNE PVC A BILLE A COLLER JOINT PTFE
VALVULA COLAR PTFE

Ref.	Ø (mm)			€	Dimensiones A-B-C
4211	20	-	40	11,3891	76x51x71
4212	25	-	40	14,1008	98x60x79
4213	32	-	30	18,6414	117x74x99
4214	40	-	20	23,7495	126x88x110
4215	50	-	15	31,5693	142x100x131
4216	63	-	10	40,0450	148x116x147
4218	90	-	2	306,4280	
4219	110	-	2	461,9320	
4255	50 (NPT)	-	15	34,7262	142x100x131
4256	63 (NPT)	-	10	44,0495	148x116x147
4258	90 (NPT)	-	2	337,0710	
4259	110 (NPT)	-	2	508,1170	

*Los articulos NPT se fabricarán bajo pedido



VÁLVULA PVC HEMBRA ASIENTO PTFE
FEMALE THREADED PVC BALL VALVE WITH PTFE JOINT
VANNE PVC A BILLE FEMELLE AVEC JOINT PTFE
VALVULA ROSCAR HEMBRA PTFE

Ref.	Ø (")			€	Dimensiones A-B-C
4221	1/2	-	40	11,7297	76x51x71
4222	3/4	-	40	14,2774	98x60x79
4223	1	-	30	19,3729	117x74x99
4224	1 1/4	-	20	24,3170	126x88x110
4225	1 1/2	-	15	32,4143	142x100x131
4226	2	-	10	40,8396	148x116x147
4228	3	-	2	323,2320	
4229	4	-	2	489,6990	
4265	1 1/2 (NPT)	-	15	35,6558	142x100x131
4266	2 (NPT)	-	10	44,9235	148x116x147
4268	3 (NPT)	-	2	355,5550	
4269	4 (NPT)	-	2	538,6680	



VÁLVULA PVC TOMA FITTING ASIENTO PTFE
FITTING PVC BALL VALVE WITH PTFE JOINT
VANNE PVC A BILLE RACCORD FITTING AVEC JOINT PTFE
VALVULA FITTING PVC PTFE

Ref.	Ø (mm)			€	Dimensiones A-B-C
4231	20	-	40	14,0630	161x51x71
4232	25	-	40	17,0018	190x60x79
4233	32	-	30	23,2450	235x74x99
4234	40	-	20	29,0342	265x88x110
4235	50	-	15	38,7333	310x100x131
4236	63	-	10	48,9242	337x116x147



VÁLVULA PVC MACHO ASIENTO PTFE
MALE THREADED PVC BALL VALVE WITH PTFE JOINT
VANNE PVC A BILLE MALE AVEC JOINT PTFE
VALVULA ROSCAR MACHO PTFE

Ref.	Ø (")			€	Dimensiones A-B-C
4241	1/2	-	40	11,7297	100x51x71
4242	3/4	-	40	14,2774	125x60x79
4243	1	-	30	19,3729	150x74x99
4244	1 1/4	-	20	24,3170	167x88x110
4245	1 1/2	-	15	32,4143	196x100x131
4246	2	-	10	40,8396	221x116x147





Extraemos accesorios 1,2,3 y 4 del producto.
We extract 1,2,3 and 4 accessories from the product.

Colocamos los accesorios extraídos en el tubo.
We put the extracted accessories in the tube.



Introducimos el tubo dentro del cuerpo del producto
We introduce the tube into the product body



Juntamos los accesorios 1,2,3 y 4 con el cuerpo del producto.
We join the 1,2,3 and 4 accessories with the product body.



Enroscamos el accesorio 1 con el cuerpo del producto y apretamos con la llave.
We screw the accessory 1 with the product body and tighten with the key.



***Llaves de apretar fitting disponibles (Referencias 0550, 0551 y 0552).**

***Wrench for fastening fitting available (References 0550, 0551 and 0552).**



ENLACE FITTING ROSCA HEMBRA
FEMALE THREADED FITTING UNION P.E.
RACCORD PRESSION TARAUDE P.E.
FITTING R/F

Ref.	Ø (mm - ")		€	Dimensiones A-B-C
4410	16 - 1/2	- 100	1,4757	62x41x41
4411	20 - 1/2	- 100	1,1946	62x41x41
4412	25 - 3/4	- 100	1,4702	76x48x48
4413	32 - 1	- 100	2,0114	88x57x57
4414	40 - 1 1/4	- 50	3,6072	102x68x68
4415	50 - 1 1/2	- 50	5,4486	119x83x83
4416	63 - 2	- 30	7,5802	140x103x103
4417	75 - 2 1/2	- 8	14,9207	166x119x119
4418	90 - 3	- 6	25,5657	175x145x145



ENLACE FITTING ROSCA MACHO
MALE THREADED FITTING UNION P.E.
RACCORD PRESSION FILETÉ P.E.
FITTING R/M

Ref.	Ø (mm - ")		€	Dimensiones A-B-C
4420	16 - 1/2	- 100	1,2991	69x41x41
4421	20 - 1/2	- 100	0,9280	69x41x41
4422	25 - 3/4	- 100	1,2162	82x48x48
4423	32 - 1	- 100	1,9603	101x57x57
4424	40 - 1 1/4	- 50	3,4811	113x68x68
4425	50 - 1 1/2	- 50	4,5657	113x68x83
4426	63 - 2	- 26	7,0252	156x103x103
4427	75 - 2 1/2	- 8	12,7766	177x118x118
4428	90 - 3	- 6	20,2432	193x144x144



PIEZAS PARA RIEGO, BAJA PRESIÓN

TE FITTING CRUZ MACHO
FITTING TE MALE
CROIX PRESSION FILETE MALE
CRUZETA FITTING MACHO

Ref.	Ø (mm)		€	Dimensiones A-B-C
4301	25-3/4	- 100	3,8800	-
4302	32-1"	- 70	5,2000	204X170X57

CARACTERISTICAS FITTING

- Accesorios para tubería de presión, fabricados en P.D.F.V. ingles (Polipropileno con Fibra de Vidrio) en las proporciones adecuadas en cuerpos y tuercas.
- Prisioneros de Poliamida.
- Arandela en A.B.S.
- Juntas tóricas.

Este producto, por su especial diseño tanto exterior como interior, está preparado para tuberías de 4-6-10-16 ATM P.E.B.D. (Polietileno Baja Densidad). Además, hay que tener en cuenta los diámetros de tuberías que están calibrados en su medida, toda uniforme.

Las distintas referencias de roscas machos y roscas hembras están preparadas para ser roscadas en accesorios que presten las medidas adecuadas en sus roscas en producto P.P.

Se recomienda que la manguera tenga un corte limpio y homogéneo en su círculo, no presentar la manguera chafada, por lo que ganaremos rapidez en su montaje y obtendremos un resultado positivo en todo su conjunto de ensamblaje.



PIEZAS PARA RIEGO, BAJA PRESIÓN

CRUZ FITTING
CROSS FITTING
CROIX PRESSION
CRUZETA FITTING

Ref.	Ø (mm)		€	Dimensiones A-B-C
4305	25-3/4	- 75	4,1200	0
4306	32-1"	- 50	5,9000	204X204X57

FITTING CHARACTERISTICS

- Accessories for pressure pipes, made of P.D.F.V. (polyethylene with fibreglass) with bodies and threaded connectors made in adequate proportions.
- Polyamide fasteners.
- A.B.S. washers.
- O-Rings

This product is ready for 4-6-10-16 ATM P.E.B.D. (low density polyethylene) thanks to both its outer and interior design. Please, bear in mind that the pipe diameters are even and proportionally well calibrated.

Different referencies of male and female threaded connectors are ready to be screwed on/in accessories that present suitable measures on their threaded connectors, and o P.P. product.

It is recommended to have the hose with a clean uniform cut on the diameter. Do not present a squashed hose, so we can speed up the installation process and obtain positive results in the assembly.



8 435277 944108



8 435277 944115



8 435277 944122



8 435277 944139



8 435277 944146



8 435277 944153



8 435277 944160



8 435277 944177



8 435277 944184



8 435277 944207



8 435277 944214



8 435277 944221



8 435277 944238



8 435277 944245



8 435277 944252



8 435277 944269



8 435277 944276



8 435277 944283



8 435277 943019



8 435277 943026



8 435277 943057



8 435277 943064



8 435277 945457



8 435277 945464

- 8 435277 944306
- 8 435277 944313
- 8 435277 944320
- 8 435277 944337
- 8 435277 944344
- 8 435277 944351
- 8 435277 944368
- 8 435277 944375
- 8 435277 944382
- 8 435277 944429
- 8 435277 944436
- 8 435277 944443
- 8 435277 944450
- 8 435277 944467
- 8 435277 944474
- 8 435277 944481
- 8 435277 944528
- 8 435277 944535
- 8 435277 944603
- 8 435277 944610
- 8 435277 944627
- 8 435277 944634
- 8 435277 944641
- 8 435277 944658
- 8 435277 944665
- 8 435277 944672
- 8 435277 944689



MANGUITO FITTING P.E.
FITTING UNION P.E.
RACCORD PRESSION P.E.
FITTING UNIAO P.E.

Ref.	Ø (mm)			€	Dimensiones A-B-C
4430	16	-	100	2,0685	104x41x41
4431	20	-	100	1,5760	104x41x41
4432	25	-	100	1,9315	119x48x48
4433	32	-	100	2,7579	139x57x57
4434	40	-	50	5,7388	162x67x67
4435	50	-	30	8,1099	185x83x83
4436	63	-	24	12,1838	212x103x103
4437	75	-	10	20,2433	272x118x118
4438	90	-	6	33,8774	292x145x145



TAPÓN FITTING P.E.
FITTING PLUG P.E.
BOUCHON PRESSION P.E.
FITTING TACO P.E.

Ref.	Ø (mm)			€	Dimensiones A-B-C
4460	16	-	100	1,4631	59x41x41
4461	20	-	100	1,0450	59x41x41
4462	25	-	100	1,3773	72x48x48
4463	32	-	100	1,9507	84x57x57
4464	40	-	50	3,4685	98x68x68
4465	50	-	50	6,1171	118x83x83
4466	63	-	30	9,2576	127x104x104
4467	75	-	8	21,3444	155x118x118
4468	90	-	6	32,6162	166x145x145



MANGUITO FITTING REDUCIDO P.E.
REDUCING FITTING UNION P.E.
RACCORD PRESSION REDUIT P.E.
FITTING UNIAO REDUCAO P.E.

Ref.	Ø (mm)			€	Dimensiones A-B-C
4442	25 - 20	-	50	2,5351	129x57x57
4443	32 - 25	-	60	3,6198	129x57x57
4444	40 - 32	-	30	5,7388	148x67x67
4445	50 - 40	-	20	8,1099	175x83x83
4446	63 - 50	-	20	12,1333	205x103x103
4447	75 - 63	-	10	23,2072	236x121x121
4448	90 - 75	-	6	35,1135	269x144x144



MANGUITO FITTING PASAMUROS P.E.
FITTING TANK CONNECTOR UNION P.E.
RACCORD PRESSION TRAVERSE-PAROI P.E.
FITTING UNIAO PASSA MUROS P.E.

Ref.	Ø (mm - ")			€	Dimensiones A-B-C
4452	25 - 3/4	-	50	4,4396	128x52x52
4453	32 - 1	-	50	6,7351	152x60x60



TE FITTING IGUAL P.E.
TEE FITTING P.E.
TE PRESSION P.E.
FITTING TE P.E.

Ref.	Ø (mm)			€	Dimensiones A-B-C
4510	16	-	100	3,2289	125x82x82
4511	20	-	100	2,6138	125x82x82
4512	25	-	100	3,2162	145x97x48
4513	32	-	70	4,6354	175x116x57
4514	40	-	30	8,7153	202x133x68
4515	50	-	16	13,0414	240x160x83
4516	63	-	10	18,5658	283x193x103
4517	75	-	5	42,3250	381x236x122
4518	90	-	4	58,0180	411x256x146



TE FITTING MACHO P.E.
MALE THREADED FITTING TEE P.E.
TE PRESSION FILETÉ P.E.
FITTING TE MACHO P.E.

Ref.	Ø (mm - ")			€	Dimensiones A-B-C
4530	16 - 1/2	-	100	2,6612	124x56x41
4531	20 - 1/2	-	100	2,1548	124x56x41
4532	25 - 3/4	-	100	3,0120	145x65x48
4533	32 - 1	-	80	3,7774	174x176x57
4534	40 - 1 1/4	-	40	6,0919	202x89x67
4535	50 - 1 1/2	-	16	8,5135	140x113x83
4536	63 - 2	-	10	13,3945	283x138x103
4537	75 - 2 1/2	-	6	32,7928	390x144x122
4538	90 - 3	-	3	44,1441	429x155x144



TE FITTING REDUCIDO P.E.
REDUCING FITTING TE P.E.
TE PRESSION REDUIT P.E.
FITTING TE REDUCAO P.E.

Ref.	Ø (mm)			€	Dimensiones A-B-C
4542	25 - 20	-	100	3,8089	146x89x48
4543	32 - 25	-	70	4,9567	173x106x57
4544	40 - 32	-	50	7,7568	203x125x68
4545	50 - 40	-	16	10,8468	239x146x83
4546	63 - 50	-	10	16,3585	284x184x104



TE FITTING HEMBRA P.E.
FEMALE THREADED FITTING TEE P.E.
TE PRESSION TARAUE P.E.
FITTING TE HEMBRA P.E.

Ref.	Ø (mm - ")			€	Dimensiones A-B-C
4521	20 - 1/2	-	100	2,2973	124x51x41
4522	25 - 3/4	-	100	3,2979	145x57x48
4523	32 - 1	-	80	4,6865	175x69x57
4524	40 - 1 1/4	-	40	7,2522	203x79x67
4525	50 - 1 1/2	-	16	10,4811	240x98x83
4526	63 - 2	-	10	16,5856	183x121x103



- 8 435277 946102
- 8 435277 946119
- 8 435277 946126
- 8 435277 946133
- 8 435277 946140
- 8 435277 946157
- 8 435277 946164
- 8 435277 946171
- 8 435277 946188
- 8 435277 946201
- 8 435277 946218
- 8 435277 946225
- 8 435277 946232
- 8 435277 946249
- 8 435277 946256
- 8 435277 946263
- 8 435277 946270
- 8 435277 946287
- 8 435277 946317
- 8 435277 946324
- 8 435277 946331
- 8 435277 946348
- 8 435277 946355
- 8 435277 946362



CODO FITTING IGUAL P.E.
FITTING ELBOW P.E.
COUDE PRESSION P.E.
FITTING JOELHO P.E.

Ref.	Ø (mm)			€	Dimensiones A-B-C
4610	16	-	100	2,1946	88x88x41
4611	20	-	100	1,7766	88x88x41
4612	25	-	100	2,1033	104x104x48
4613	32	-	100	3,0326	125x125x57
4614	40	-	40	6,0036	142x142x67
4615	50	-	20	8,5261	172x172x83
4616	63	-	12	13,1675	205x205x104
4617	75	-	6	31,4223	241x241x135
4618	90	-	6	45,4054	268x268x146



CODO FITTING MACHO P.E.
MALE THREADED FITTING ELBOW P.E.
COUDE PRESSION FILETÉ P.E.
FITTING JOELHO MACHO P.E.

Ref.	Ø (mm - ")			€	Dimensiones A-B-C
4620	16 - 1/2	-	100	2,0559	82x67x41
4621	20 - 1/2	-	100	1,6643	82x67x41
4622	25 - 3/4	-	100	2,0522	97x76x48
4623	32 - 1	-	100	2,4301	116x87x57
4624	40 - 1 1/4	-	30	3,8847	135x104x68
4625	50 - 1 1/2	-	30	5,1711	160x125x93
4626	63 - 2	-	20	7,1891	192x157x103
4627	75 - 2 1/2	-	6	26,6805	266x170x122
4628	90 - 3	-	6	36,8676	284x195x144



CODO FITTING HEMBRA P.E.
FEMALE THREADED FITTING ELBOW P.E.
COUDE PRESSION TARAUDE P.E.
FITTING JOELHO HEMBRA P.E.

Ref.	Ø (mm)			€	Dimensiones A-B-C
4631	20 - 1/2	-	100	2,9765	84x54x41
4632	25 - 3/4	-	100	3,5063	97x61x48
4633	32 - 1	-	100	4,2757	117x80x57
4634	40 - 1 1/4	-	30	5,2217	137x98x68
4635	50 - 1 1/2	-	30	6,7856	161x101x82
4636	63 - 2	-	20	8,1604	195x124x103





CODO FITTING 3 SALIDAS (2 FITTING - 1 R/HEMBRA) P.E.
3 OULETS FITTING ELBOW (2 FITTING - 1 FEMALE) P.E.
COUDE PRESSION 3 SORTIES (2 PRESSION - 1 TARAUDÉ) P.E.
JOELHO FITTING 3 SAIDAS (2 FITTING - 1 R/H)

Ref.	Ø (mm - ")			€	Dimensiones A-B-C
4642	25 - 25 - (1/2)	-	50	5,6631	102x102x53
4643	32 - 32 - (3/4)	-	50	6,9117	122x122x59



CODO FITTING 3 SALIDAS (1 FITTING - 1 R/HEMBRA - 1 R/MACHO) P.E.
3 OULETS FITTING ELBOW (1 FITTING - 1 FEMALE - 1 MALE) P.E.
COUDE PRESSION 3 SORTIES (1 PRESSION - 1 FILETÉ - 1 TARAUDÉ) P.E.
JOELHO FITTING 3 SAIDAS (1 FITTING - 1 R/H - 1 R/M)

Ref.	Ø (mm - ")			€	Dimensiones A-B-C
4652	25 - 3/4 - (1/2)	-	50	5,0072	93x73x53
4653	32 - 1 - (3/4)	-	50	6,3315	115x88x59



CODO FITTING 3 SALIDAS (1 FITTING - 1 R/HEMBRA - 1 R/HEMBRA) P.E.
3 OULETS FITTING ELBOW (1 FITTING - 1 FEMALE - 1 FEMALE) P.E.
COUDE PRESSION 3 SORTIES (1 PRESSION - 1 FILETÉ - 1 FILETÉ) P.E.
JOELHO FITTING 3 SAIDAS (1 FITTING - 1 R/H - 1 R/H WW)

Ref.	Ø (mm - ")			€	Dimensiones A-B-C
4662	25 - 3/4 - (1/2)	-	50	5,6631	98x63x53
4663	32 - 1 - (3/4)	-	50	6,9747	118x80x60



CODO FITTING PARA GRIFO P.E.
TAP COUPLING FITTING ELBOW P.E.
COUDE PRESSION FILETÉ POUR ROBINET P.E.
FITTING JOELHO TOQUE P.E.

Ref.	Ø (mm - ")			€	Dimensiones A-B-C
4671	20 - 1/2	-	100	4,0108	53x49x89
4672	25 - 3/4	-	100	4,3387	64x59x102





MANGUITO ROSCA HEMBRA
FEMALE THREADED UNION
MANCHON FEMELLE
UNIAO FEMEA

Ref.	Ø (")			€	Dimensiones A-B-C
1520	3/8	-	500	0,5213	26x24x24
4711	1/2	-	200	0,5213	30x30x30
4712	3/4	-	200	0,5995	37x35x35
4719	3/4 (Largo)	-	200	0,7033	
4713	1	-	100	1,6161	41x44x44
4714	1 1/4	-	100	1,8246	40x52x52
4715	1 1/2	-	100	2,5810	55x62x62
4716	2	-	100	4,1190	61x76x76
4717	2 1/2	-	20	12,3827	98x95x95
4718	3	-	10	13,6864	113x111x111



MANGUITO ROSCA HEMBRA REDUCIDO
REDUCING FEMALE THREADED UNION
MACHON FEMELLE REDUIT
UNIAO FEMEA REDUCAO

Ref.	Ø (" - ")			€	Dimensiones A-B-C
4722	3/4 - 1/2	-	200	0,5995	35x35x35
4723	1 - 3/4	-	100	1,6161	41x44x44
4724	1 1/4 - 1	-	100	1,8246	42x52x52
4725	1 1/2 - 1 1/4	-	100	2,5810	55x61x61
4726	2 - 1 1/2	-	100	4,1190	61x76x76
4727	2 1/2 - 2	-	20	12,3827	99x93x93
4728	3 - 2 1/2	-	10	13,6864	113x111x111



RACOR MARSELLA
MARSELLA UNION
RACCORD MARSELLA
UNIAO PP F/M

Ref.	Ø (" - ")			€	Dimensiones A-B-C
4730	1/2 - 3/4	-	200	1,1278	37x35x35
4731	1/2 - 1	-	200	1,4043	40x45x45
4732	1/2 - 1 1/4	-	100	1,8938	51x52x52
4733	3/4 - 1	-	200	1,5449	40x45x45
4734	3/4 - 1 1/4	-	100	1,8938	51x52x52
4735	3/4 - 1 1/2	-	200	2,9152	52x62x62
4736	1 - 1 1/4	-	200	1,8938	48x51x51
4737	1 - 1 1/2	-	200	2,9152	54x70x70
4738	1 - 2	-	100	4,3727	53x70x70
4739	1 - 2 1/2	-	50	8,0000	82,69x82,69x57x35
4740	2 - 2 1/2	-	50	8,0000	82,69x82,69x64,24
4741	1 - 3	-	25	24,0000	103,6x103,6x68,8
4729	2 - 3	-	25	24,0000	103,6x103,6x77



TUERCA REDUCCIÓN
REDUCING THREADED UNION MALE - FEMALE
RACCORD DE REDUCTION MALE - FEMELLE
UNIAO PP M/F

Ref.	Ø (" - ")			€	Dimensiones A-B-C
4742	3/4 - 1/2	-	200	0,4693	31x30x30
4743	1 - 3/4	-	200	0,5473	45x36x36
4756	1 3/4 (Sin fin)	-	200	0,6567	45x36x36
4744	1 1/4 - 1	-	100	0,8968	44x50x50
4745	1 1/2 - 1 1/4	-	100	1,8246	40x53x53
4746	2 - 1 1/2	-	100	2,3463	39x63x63
4747	2 1/2 - 2	-	50	3,1282	44x79x79
4748	3 - 2 1/2	-	25	5,7353	51x93x93
4750	1 - 1/2	-	200	0,6568	45x36x36
4751	1 1/4 - 3/4	-	200	0,6568	47x45x45
4752	1 1/2 - 3/4	-	100	2,1896	39x53x53
4753	1 - 1/2 - 1	-	100	2,1896	39x53x53
4754	2 - 1	-	100	2,8155	39x62x62
4755	2 - 1 1/4	-	100	2,8155	39x63x63



**MACHÓN ROSCADO
MALE THREADED UNION
MACHON FILETÉ
CASQUILHO DUPLO**

**MACHÓN ROSCADO REDUCIDO
MALE REDUCING THREADED UNION
MANCHON FILETÉ REDUIT
CASQUILHO PP RED M/M**

Ref.	Ø (")		€	Dimensiones A-B-C
4819	1/4	- 250	0,2475	27x17x17
4810	3/8	- 250	0,2475	34x19x19
4811	1/2	- 250	0,2475	33x29x29
4812	3/4	- 200	0,3125	37x35x35
4813	1	- 150	0,4693	40x39x39
4814	1 1/4	- 150	0,6516	51x45x45
4815	1 1/2	- 100	1,0428	64x53x53
4816	2	- 100	1,6944	64x62x62
4817	2 1/2	- 30	2,0854	73x79x79
4818	3	- 30	3,1282	85x93x93

Ref.	Ø ("-")		€	Dimensiones A-B-C
4822	3/4 - 1/2	- 200	0,3125	38x35x35
4823	1 - 3/4	- 150	0,4693	40x39x39
4824	1 1/4 - 1	- 150	0,6516	47x45x45
4825	1 1/2 - 1 1/4	- 100	1,0428	59x53x53
4826	2 - 1 1/2	- 100	1,6944	65x63x63
4827	2 1/2 - 2	- 30	2,0854	69x79x79
4828	3 - 2 1/2	- 30	3,1282	81x93x93



**CODO MACHO
MALE THREADED ELBOW
COUDE FILETÉ
JOELHO MAHCO**

**TE MACHO
MALE THREADED TE
TE FILETE
TE MACHO**

Ref.	Ø (")		€	Dimensiones A-B-C
4831	1/2	- 100	1,1112	55x55x20
4832	3/4	- 100	1,2530	56x56x25
4833	1	- 100	1,7258	57x57x32
4834	1 1/4	- 50	2,2697	62x62x41
4835	1 1/2	- 50	3,7353	80x80x47
4836	2	- 50	7,1166	94x94x58

Ref.	Ø (")		€	Dimensiones A-B-C
4841	1/2	- 100	1,5132	72x51x21
4842	3/4	- 100	1,7258	72x52x26
4843	1	- 100	2,2697	72x52x32
4844	1 1/4	- 50	3,1210	80x60x41
4845	1 1/2	- 50	5,3904	101x73x47
4846	2	- 50	9,9535	121x90x60



**TAPÓN MACHO
MALE PLUG
BOUCHON MALE
TACO MACHO**

Ref.	Ø (")			€	Dimensiones A-B-C
4919	1/4	-	250	0,2476	17x17x17
4910	3/8	-	250	0,2476	21x19x19
4911	1/2	-	250	0,2476	22x29x29
4912	3/4	-	200	0,3126	27x35x35
4913	1	-	150	0,6516	29x39x39
4914	1 1/4	-	150	0,7824	36x45x45
4915	1 1/2	-	100	1,0429	42x52x52
4916	2	-	100	1,6945	42x62x62
4917	2 1/2	-	30	2,0854	48x78x78
4918	3	-	30	3,1283	57x92x92

**TAPÓN HEMBRA
FEMALE PLUG
BOUCHON FEMELLE
TACO FEMEA**

Ref.	Ø (" - ")			€	Dimensiones A-B-C
4921	1/2	-	250	0,6385	20x39x39
4922	3/4	-	200	0,7449	21x42x42
4923	1	-	150	1,1278	25x45x45
4924	1 1/4	-	150	1,5535	32x51x51
4925	1 1/2	-	100	2,0428	41x69x69
4926	2	-	100	3,8304	41x69x69
4928	3	-	50	7,1673	45x103x103

**TAPÓN MACHO HEXAGONAL LARGO
MALE LONG PLUS WITH HEXAGON HEAD
LONG BOUCHON MALE TETE HEXAGONAL
TACO MACHO HEXAGONAL COMPIMIDO PRETO**

Ref.	Ø (" - ")			€	Dimensiones A-B-C
4931	1/2	-	500	0,4457	69x20x12
4932	1/2	-	500	0,5180	69x20x12
4933	1/2	-	500	0,5180	69x20x12

TAPÓN MACHO HEXAGONAL LARGO
Largo idóneo para salvar el alcatado en las PRUEBAS de obras.
Incorpora una junta para asegurar su estanqueidad

CARACTERÍSTICAS ROSCADAS
Accesorios auxiliares fabricados con materia prima de alta calidad, elaborados a las temperaturas adecuadas para poder ofrecer un margen de tolerancia entre los mismos.
A merced de su diseño presenta un acabado limpio, teniendo como elemento auxiliar de la propia pieza una de las partes hexagonales para poder roscar con más seguridad y firmeza.

Las distintas referencias de roscas machos y roscas hembras están preparadas para ser roscadas en accesorios que presten las medidas adecuadas en sus roscas, en producto P.P.

**TAPÓN MACHO HEXAGONAL
MALE PLUG WITH HEXAGON HEAD
BOUCHON MALE TETE HEXAGONALE
TACO MACHO HEXAGONAL PRETO**

Ref.	Ø (" - ")			€	Dimensiones A-B-C
4941	1/2	-	500	0,1671	24x24x19
4942	1/2	-	500	0,2238	24x24x19
4943	1/2	-	500	0,2238	24x24x19

LARGE HEXAGONAL MALE PLUG
Ideal length to overcome the tiling
It includes a joint to secure its watertightness.

THREADED CONNECTORS CHARACTERISTICS
Assistant accessories made of the highest quality raw material and manufactured at the right temperatures to offer a tolerant margin between them.

At the mercy of their design, they presents a clean finish, having as an assistant component (part of their body) an hexagonal part, so that they can be screwed in much safer and with firmness.

The difference references of male and female threaded connectors are ready to be screwed on/in accessories that present suitable measures on their threaded connectors (and on PP product)



ACCESORIOS DE EVACUACIÓN

EVACUATION ACCESSOIRES



ACCESSOIRES POUR L'EVACUATION

ACCESORIOS DE EVACUAÇÃO



L-98

SUMIDERO SIFÓNICO VERTICAL
VERTICAL DRAIN FLOOR
AVALOIR SORTIE VERTICALE COLAR
SUMIDOURO SIFONICO VERTICAL COLAR

Ref.	Sup (mm) - Ø (mm)			€	Dimensiones A-B-C
6024	104x104 - 50-40	-	50	5,6618	104x104x45
6025	104x104 Inox - 50-40	-	50	8,2404	104x104x45



L-99

SUMIDERO SIFÓNICO VERTICAL Y HORIZONTAL
VERTICAL OR HORIZONTAL DRAIN FLOOR
SIPHON DE COUR SORTIE VERTICALE OU HORIZONTALE
SUMIDOURO SIFONICO VERTICAL/HORIZONTAL PVC COLAR

Ref.	Sup (mm) - Ø (mm)			€	Dimensiones A-B-C
6010	104x104 - 50	-	30	6,6594	90x104x104
6011	104x104 Inox - 50	-	30	8,7587	90x104x104

Incluye un tapón
It includes a cap



L-100

SUMIDERO SIFÓNICO VERTICAL
VERTICAL DRAIN FLOOR
AVALOIR SORTIE VERTICALE COLAR
SUMIDOURO SIFONICO VERTICAL COLAR

Ref.	Sup (mm) - Ø (mm)			€	Dimensiones A-B-C
6020	150x150 - 50-75	-	48	8,7784	151x151x65
6021	200x200 - 90-110	-	20	13,2901	200x200x85
6022	250x250 - 90-110	-	12	19,0559	250x250x87
6023	300x300 - 110-125	-	6	36,8432	300x300x100



L-103 Alta Resistencia

SUMIDERO SIFÓNICO VERTICAL
VERTICAL DRAIN FLOOR
AVALOIR SORTIE VERTICALE COLAR
SUMIDOURO SIFONICO VERTICAL COLAR

Ref.	Sup (mm) - Ø (mm)			€	Dimensiones A-B-C
6050	150x150 - 50-75	-	48	19,4594	151x151x65
6051	200x200 - 90-110	-	20	28,1081	200x200x85
6052	250x250 - 90-110	-	12	36,7567	250x250x87
6053	300x300 - 110-125	-	6	46,8000	300x300x110



L-101

CALDERETA SIFÓNICA VERTICAL
VERTICAL BELL DRAIN
SIPHON DE COUR SORTIE VERTICALE AVEC ENTONNOIR
CAIXA SIFONICA EXTENSIVEL VERTICAL COLAR

Ref.	Sup (mm) - Ø (mm)			€	Dimensiones A-B-C
6030	150x150 - 50-75	-	22	12,7711	216x210x104
6031	200x200 - 90-110	-	12	23,0630	289x275x128
6032	250x250 - 90-110	-	6	28,1225	341x338x143
6033	300x300 - 110-125	-	3	55,2648	423x423x187



L-102

CALDERETA SIFÓNICA HORIZONTAL
HORIZONTAL BELL DRAIN
SIPHON DE COUR SORTIE HORIZONTAL AVEC ENTONNOIR
CAIXA SIFONICA EXTENSIVEL HORIZONTAL COLAR

Ref.	Sup (mm) - Ø (mm)			€	Dimensiones A-B-C
6040	150x150 - 75	-	20	12,7711	210x210x106
6041	200x200 - 90	-	10	23,0630	276x276x130
6042	250x250 - 110	-	6	25,5659	333x333x141



ACTA Nº: AE111339
MATERIAL ENSAYADO: SUMIDERO
ALBARÁN Nº: 60514-1

AIDICO
INSTITUTO TECNOLÓGICO DE LA CONSTRUCCIÓN

SUMIDEROS Y SIFONES PARA EDIFICIOS. MÉTODOS DE ENSAYO. ENSAYO DE CARGA (UNE- EN 1253-2:2004)

CLASE DE EQUIPO DE CUBRILIÓN DE CIERRE	L15
FECHA DEL ENSAYO	27.05.2011

RESULTADOS DEL ENSAYO:

COTA DE PASO (mm)	190
DIMENSIÓN PLATO DE CARGA (mm)	Ø 110
FUERZA DE CONTROL (kN)	15
VELOCIDAD DE CARGA (kN/s)	3
FLIJA RESIDUAL (mm) (después de aplicar los 2/3 de la fuerza de control 5 veces :)	0,21
RESULTADO (APARICIÓN O NO DE FISURAS) (después de la aplicación de la fuerza de control):	SATISFACTORIO

Fácil cierre y apertura con un cuarto de giro. Incluye llave de apertura y cierre.
Easy to open and close with a quarter twist. It includes an opening and closing key.

Tornillo y chapa metálicos
screw and metalic plates

Junta de estanqueidad alojada en la base de la tapa
Stagnancy joint on the lid base.

Cuando no se prolonga con tubo de 110 mm se sustituye con el casquillo adaptador.
If it is not adjusted with a 110 mm tube, it can be replaced with the adjustable fitting.

Cavidad de desagüe amplia. Para espacios reducidos, utilizar modelo corto (altura 90 mm.)
Wide drainage cavity. Use short model for small spaces (90 mm high)

5 entradas de 40 mm
1 salida de 50 mm
3 tapones de 40 mm
5 inlets of 40 mm
1 outlet of 50 mm
3 plugs of 40 mm

Espesores de las embocaduras según norma EN 1329.
Thickness according to EN 1329 normative.



Ensayos realizados sobre un sumidero sifónico vertical de 250x250 "ALTA RESISTENCIA" contra la norma UNE-EN- 1253-2:2004 por AIDICO. El resultado es SATISFACTORIO para la categoría L15. La rotura se produjo a 67,72 kN.

La categoría L15 es para, según la norma, "zonas con tráfico de vehículos ligeros, excluidas las carretillas elevadoras de horquilla, utilizadas en recintos comerciales." Para más información consultar la norma de referencia.

Tests performed at a 250x250 vertical drain trap "ALTA RESISTENCIA" against UNE-EN- 1253-2:2004 for AIDICO. The result is SATISFACTORY for the L15 category. The break occurred at 67,72 kN.

The category L15 is for, according to the standard, "areas with light vehicle traffic, other than a forklift, used in commercial venues." For more information see the reference standard.

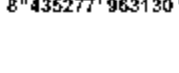

L-104

BOTE SIFÓNICO
FLOOR TRAP
BOITE SIPHONIQUE
SIFAO PVC

Ref.	Ø (mm)			€	Dimensiones A-B-C
6310	110	-	20	11,2747	169x169x103
6311	110 - Corto	-	20	11,2747	169x169x90



L-104

TAPA BOTE SIFÓNICO
COVER FOR FLOOR TRAP
COUVERCLE POUR BOITE SIPHONIQUE
TAMPA SIFAO PVC

Ref.	Ø (mm)			€	Dimensiones A-B-C
6313	110	1	50	5,8653	



L-105

MANGUITO INODORO RECTO
SANITARY CONNECTOR
PIPE SANITAIRE
CANHAO SANITA RECTO

Ref.	Ø (mm)			€	Dimensiones A-B-C
6210	90	-	40	4,8721	137x137x145
6211	110	-	35	4,8721	135x135x146



L-105

MANGUITO INODORO EXCÉNTRICO
ECCENTRIC SANITARY CONNECTOR
PIPE SANITAIRE EXCENTRIQUE
CANHAO SANITA EXCENTRICO

Ref.	Ø (mm)			€	Dimensiones A-B-C
6220	90	-	40	4,8721	142x137x146
6221	110	-	35	4,8721	137x137x146



L-106

MANGUITO INODORO RECTO JUNTA LABIADA
SANITARY CONNECTOR WITH LIP JOIN
PIPE SANITAIRE AVEC JOINT A LEVRE
CANHAO SANITA RECTO JUNTA LABIADA

Ref.	Ø (mm)			€	Dimensiones A-B-C
6230	90	-	35	6,4864	137x137x145



L-106

MANGUITO INODORO EXCÉNTRICO JUNTA LABIADA
ECCENTRIC SANITARY CONNECTOR WITH LIP JOIN
PIPE SANITAIRE EXCENTRIQUE AVEC JOINT A LEVRE
CANHAO SANITA EXCENTRICO JUNTA LABIADA

Ref.	Ø (mm)			€	Dimensiones A-B-C
6240	90	-	35	6,4864	135x135x146

JUNTA ADAPTA

* La Junta Adapta es la única que se ajusta a la válvula garantizando que no se cae durante su instalación y permite desmontarla y montarla cuando lo necesitamos.

* La superficie de contacto es la mayor del mercado, ajustandose perfectamente al sanitario.

* This adjustable joint is the only one that can be adjusted to a valve guaranteeing that it does not fall out during its installation and we can assemble or dismantle it when we need it.

* The surface contact is the largest of the market, and it can be perfectly adjusted to any bathroom fittings.



SISTEMA ANTI-FUGA

La Junta tórica garantiza la estanqueidad, los topes imposibilitan que se desmonte la pieza durante la instalación del plato de ducha.

The O-Ring guarantees its stagnancy and the tops prevent the piece from being falling apart during the installation of the shower plate.



SIFON ON-Off

- El casquillo extraíble permite hacerlo sifón según la voluntad del usuario. Es el único que permite acceder a la válvula para su limpieza y desatasque sin desmontar el plato de ducha.

You can convert it to a siphon by removing its ferrule. It is the only one that allows you to access the valve to clean and unblock it without removing the shower plate.





8 435277 965110



8 435277 965127



8 435277 965134



8 435277 965141



8 435277 965158



8 435277 965165



8 435277 965172



8 435277 965301



8 435277 965318



8 435277 965325

L-2
L-2T
REF.: 6512
REF.: 6513

SIFÓN BOTELLA EXTENSIBLE CON / SIN TOMA
ADJUSTABLE BOTTLE TRAP WITH OR WITHOUT INTAKE
SIPHON EVIER EXTENSIBLE AVEC OU SANS PRISE
SIFAO GARRAFA EXTENSIBLE

Ref.	Ø (" - mm)			€	Dimensiones A-B-C
6512	1 1/2 - 40	1	40	6,2191	76x95x193 (281)
6513	1 1/2 - 40	1	40	6,8383	76x95x193 (281)

L-5

SIFÓN BOTELLA EXTENSIBLE 2 TOMAS
ADJUSTABLE BOTTLE TRAP WITH 2 INTAKES
SIPHON EVIER EXTENSIBLE AVEC 2 PRISES
SIFAO GARRAFA EXTENSIBLE 2 TOMAS

Ref.	Ø (" - mm)			€	Dimensiones A-B-C
6511	1 1/2 - 40	1	30	9,0397	228x95x357 (421)

JUN ADAPTA
L-3

SIFÓN BOTELLA CON VÁLVULA Y TAPÓN
BOTTLE TRAP WITH VALVE AND PLUG
SIPHON EVIER AVEC BONDE EXTENSIBLE ET BOUCHON
SIFAO GARRAFA EXTENSIBLE CON VALVULA Y TACO

Ref.	Ø (" - mm) - chapa			€	Dimensiones A-B-C
6514	1 1/2 - 40 - 70	1	35	9,2462	78x95x190 (264)
6515	1 1/2 - 40 - 85	1	35	9,7689	78x95x190 (264)
6516	1 1/2 - 40 - 115	1	35	10,9248	78x95x190 (264)

JUN ADAPTA
L-4

SIFÓN BOTELLA CON VÁLVULA, TAPÓN Y CADENA
BOTTLE TRAP WITH VALVE, CHAIN AND PLUG
SIPHON EVIER AVEC BONDE EXTENSIBLE, CHAINE ET BOUCHON
SIFAO GARRAFA EXTENSIBLE CON VALVULA, TACO E CORRENTE

Ref.	Ø (" - mm) - chapa			€	Dimensiones A-B-C
6517	1 1/2 - 40 - 70	1	35	10,1267	78x95x190 (264)

L-6
L-7
REF.: 6530
REF.: 6531

SIFÓN "Y" / SIFÓN "Y" ADAPTADOR
"Y" BOTTLE TRAP / ADJUSTABLE "Y" BOTTLE TRAP
SIPHON EVIER "Y" / SIPHON EVIER "Y" EXTENSIBLE
SIFAO "Y" / SIFAO "Y" EXTENSIBLE

Ref.	Ø (" - mm)			€	Dimensiones A-B-C
6530	1 1/2 - 40	1	50	4,2790	127x55x132
6531	1 1/2 - 40	1	50	5,0634	127x55x206 (272)

JUN ADAPTA
L-8

SIFÓN "Y" CON VÁLVULA, TAPÓN Y CADENA
BOTTLE TRAP WITH VALVE, PLUG AND CHAIN
SIPHON EVIER "Y" AVEC BONDE, BOUCHON ET CHAINE
SIFAO Y CON VALVULA, TACO E CORRENTE

Ref.	Ø (" - mm) - chapa			€	Dimensiones A-B-C
6532	1 1/2 - 40 - 70	1	50	8,0353	141x75x136 (276)



SIFÓN CURVO EXTENSIBLE CON O SIN TOMA

ADJUSTABLE U-BEND BOTTLE TRAP WITH OR WITHOUT INTAKE

SIPHON COURBE EXTENSIBLE AVEC OU SANS PRISE

SIFAO CURVO EXTENSIBLE CON/SIN TOMA

Ref.	Ø (" - mm)			€	Dimensiones A-B-C
6520	1 1/2 - 40	1	40	5,8064	140x55x215 (276)
6521	1 1/2 - 40	1	40	6,4255	140x55x215 (276)



SIFÓN CURVO TOMA ELECTRODOMÉSTICO

U-BEND BOTTLE TRAP WITH WATER EVACUATE INTAKE

SIPHON COURBE POUR EVACUATION D'EAU

SIFAO CURVO TOMA ELECTRODOMESTICO

Ref.	Ø (" - mm)			€	Dimensiones A-B-C
6526	1 1/2 - 40	1	40	5,3386	164x55x190



SIFÓN CURVO CON VÁLVULA Y TAPÓN

ADJUSTABLE U-BEND BOTTLE TRAPE WITH VALVE AND PLUG

SIPHON EVIER COURBE EXTENSIBLE AVEC BONDE ET BOUCHON

SIFAO CURVO CON VALVULA E TACO

Ref.	Ø (" - mm) - chapa			€	Dimensiones A-B-C
6522	1 1/2 - 40 - 70	1	35	8,8334	157x78x193 (256)
6523	1 1/2 - 40 - 85	1	35	9,3424	157x78x193 (256)
6524	1 1/2 - 40 - 115	1	35	10,5120	



SIFÓN CURVO CON VÁLVULA, TAPÓN Y CADENA

ADJUSTABLE U-BEND BOTTLE TRAP WITH VALVE, CHAIN AND PLUG

SIPHON EVIER COURBE EXTENSIBLE AVEC BONDE, BOUCHON ET CHAINE

SIFAO CURVO CON VALVULA, TACO E CORRENTE

Ref.	Ø (" - mm) - chapa			€	Dimensiones A-B-C
6525	1 1/2 - 40 - 70	1	35	9,3837	157x78x193 (256)



SIFÓN CURVO EXTENSIBLE CON CODO

ADJUSTABLE U-BEND BOTTLE TRAP WITH ELBOW

SIPHON COURBE ADJUSTABLE AVEC COUDE

SIFAO CURVO DUPLO DESLOCADO

Ref.	Ø (" - mm)			€	Dimensiones A-B-C
6540	1 1/2 - 40	1	25	8,6132	362x55x314 (372)
6541	1 1/2 - 40 - 70 y Valvula	1	25	12,3282	378x78x440 (497)



SIFÓN BOTELLA DOBLE EVACUACIÓN CON REBOSADERO

DOUBLE EVACUATE BOTTLE TRAP WITH OVERFLOW

SIPHON A DOUBLE EVACUATION AVEC TROP PLEIN

SIFAO DUPLO CON REPIRO

Ref.	Ø (" - mm) - chapa			€	Dimensiones A-B-C
6616	1 1/2 - 40 - 70	1	10	26,1149	
6617	1 1/2 - 40 - 85	1	10	27,1469	
6618	1 1/2 - 40 - 115	1	10	29,4722	





VÁLVULA FREGADERO
SANITARY SINK DRAIN VALVE
BONDE POUR EVIER
VALVULA CON TACO

Ref.	Ø (" - mm) - chapa			€	Dimensiones A-B-C
6410	1 1/2 - 40 - 70	1	50	5,7101	78x78x63
6411	1 1/2 - 40 - 85	1	50	6,2329	
6412	1 1/2 - 40 - 115	1	50	7,4025	



VÁLVULA LAVABO-BIDET
SANITARY DRAIN BASIN
BONDE SANITAIRE
VALVULA CON TACO E CORRENTE

Ref.	Ø (" - mm) - chapa			€	Dimensiones A-B-C
6415	1 1/2 - 40 - 70	1	50	6,6181	78x78x63



VÁLVULA SIFÓNICA PLATO DUCHA
SHOWER PLATE DRAIN VALVE
SIPHON PLATEAU DOUCHE
BASE CHUVEIRO SIFONICA

Ref.	Ø (" - mm) - chapa			€	Dimensiones A-B-C
6420	1 1/2 - 40 - 80	1	50	4,2102	120x90x72
6421	1 1/2 - 40 - 70 y Tapón	1	50	4,7882	120x90x72



VÁLVULA PLATO DUCHA EXTRAPLANA
FLAT DRAIN VALVE FOR SHOWER PLATE
SIPHON PLAT PLATEAU DOUCHE
VALVULA BASE CHUEIRO SALIDA HORIZONTAL

Ref.	Ø (" - mm) - chapa			€	Dimensiones A-B-C
6425	1 1/2 - 40 - 80	1	50	5,0359	131x82x57



DOBLE SIFÓN CURVO EXTENSIBLE CON TOMA
U-BEND ADJUSTABLE DOUBLE SIPHON WITH INTAKE
DOUBLE SIPHON COURBE EXTENSIBLE
SIFAO DUPLO CURVO EXTENSIBLE

Ref.	Ø (" - mm)			€	Dimensiones A-B-C
6630	1 1/2 - 40	1	15	13,2088	554(606)x55x260(287)



DOBLE SIFÓN CURVO EXTENSIBLE CON VÁLVULA Y TAPÓN
U-BEND DOUBLE SIPHON WITH VALVE AND PLUG
SIPHON DOUBLE COURBE AVEC BONDE ET BOUCHON
SIFAO DUPLO CURVO CON VALVULA E TACO

Ref.	Ø (" - mm) - chapa			€	Dimensiones A-B-C
6631	1 1/2 - 40 - 70	1	15	19,0978	571(637)x78x260(265)
6632	1 1/2 - 40 - 85	1	15	20,1435	
6633	1 1/2 - 40 - 115	1	15	22,4550	



L-15

SIFÓN BOTELLA CON DOBLE EVACUACIÓN
BOTTLE TRAP WITH DOUBLE EVACUATE
SIPHON BOUTEILLE A DOUBLE EVACUATION
SIFAO DUPLO CON TOMA

Ref.	Ø (" - mm)			€	Dimensiones A-B-C
6610	1 1/2 - 40	1	20	10,4294	442(503)x95x276(335)



L-18

SIFÓN CURVO CON DOBLE EVACUACIÓN
U-BEND SIPHON WITH DOUBLE EVACUATE
SIPHON COURBE AVEC DOUBLE EVACUATION
SIFAO DUPLO CURVO CON TOMA

Ref.	Ø (" - mm)			€	Dimensiones A-B-C
6620	1 1/2 - 40	1	20	8,3472	463(525)x155x279(340)



L-16

SIFÓN BOTELLA CON DOBLE EVACUACIÓN EXTENSIBLE
BOTTLE TRAP WITH DOUBLE ADJUSTABLE EVACUATE
SIPHON BOUTEILLE A DOUBLE EVACUATION ADJUSTABLE
SIFAO DUPLO EXTENSIBLE CON TOMA

Ref.	Ø (" - mm)			€	Dimensiones A-B-C
6611	1 1/2 - 40	1	20	11,9842	442(503)x95x341(433)



L-19

SIFÓN CURVO CON DOBLE EVACUACIÓN EXTENSIBLE
U-BEND SIPHON WITH DOUBLE ADJUSTABLE EVACUATE
SIPHON COURBE A DOUBLE EVACUATION AJUSTABLE
SIFAO DUPLO EXTENSIBLE CURVO CON TOMA

Ref.	Ø (" - mm)			€	Dimensiones A-B-C
6621	1 1/2 - 40	1	20	11,5715	463(525)x155x355(431)



L-17

SIFÓN BOTELLA CON DOBLE EVACUACIÓN, VÁLVULA Y TAPÓN
BOTTLE TRAP WITH DOUBLE EVACUATE, VALVE AND PLUG
SIPHON BOUTEILLE A DOUBLE EVACUATION AVEC BONDE ET BOUCHON
SIFAO DUPLO EXTENSIBLE CON VALVULA E TOMA

Ref.	Ø (" - mm) - chapa			€	Dimensiones A-B-C
6612	1 1/2 - 40 - 70	1	15	18,2309	463(525)x95x333(410)
6613	1 1/2 - 40 - 85	1	15	19,2766	463(525)x95x333(410)
6614	1 1/2 - 40 - 115	1	15	21,6019	



L-20

SIFÓN CURVO CON DOBLE EVACUACIÓN, VÁLVULA Y TAPÓN
U-BEND SIPHON WITH DOUBLE ADJUSTABLE VALVE AND PLUG
SIPHON COURBE A DOUBLE EVACUATION AVEC BONDE ET BOUCHON
SIFAO DUPLO EXTENSIBLE CON TOMA

Ref.	Ø (" - mm) - chapa			€	Dimensiones A-B-C
6622	1 1/2 - 40 - 70	1	15	17,8182	442(503)x95x341(433)
6623	1 1/2 - 40 - 85	1	15	18,8638	
6624	1 1/2 - 40 - 115	1	15	21,1754	





VÁLVULA VERTICAL FREGADERO REBOSADERO
VERTICAL SINK DRAIN VALVE WITH OVERFLOW
BONDE D'EVIER VERICALE AVEC TROP PLEIN
VALVULA CON RESPIRO

Ref.	Ø (" - mm) - chapa			€	Dimensiones A-B-C
6710	1 1/2 - 40 - 70	1	50	10,4180	78x75x447
6711	1 1/2 - 40 - 85	1	25	11,2882	78x75x447
6712	1 1/2 - 40 - 115	1	25	12,3099	



VÁLVULA VERTICAL Y EXTRAPLANA BAÑERA REBOSADERO
VERTICAL AND FLAT BATHTUB DRAIN VALVE KIT WITH OVERFLOW
KIT BONDE DE BAINOIRE VERICALE AVEC TROP PLEIN
JOGO BANHEIRA SAIDA VERTICAL

Ref.	Ø (" - mm) - chapa			€	Dimensiones A-B-C
6715	1 1/2 - 40 - 70	1	25	11,5280	78x75x795
6730	1 1/2 - 40 - 70	1	25	11,9316	79x69x825



CONJUNTO VÁLVULA HORIZONTAL BAÑERA REBOSADERO
HORIZONTAL BATHTUB DRAIN VALVE KIT WITH OVERFLOW
KIT BONDE DE BAINOIRE HORIZONTALE AVEC TROP PLEIN
JOGO BANHEIRA SAIDA HORIZONTAL

Ref.	Ø (" - mm) - chapa			€	Dimensiones A-B-C
6720	1 1/2 - 40 - 70	1	25	12,2721	77x143x800



CONJUNTO VÁLVULA VERTICAL BAÑERA REBOSADERO SALIDA PVC
VERTICAL BATHTUB DRAIN VALVE KIT WITH OVERFLOW AND PVC OUTPUT
KIT BONDE DE BAINOIRE VERICALE AVEC TROP PLEIN ET SORTIE PVC
JOGO BAHEIRA SAIDA VERTICAL

Ref.	Ø (" - mm) - chapa			€	Dimensiones A-B-C
6735	1 1/2 - 40 - 70	1	25	10,9603	79X69X825
6725	1 1/2 - 40 - 70	1	25	11,8559	78x105x871



TAPÓN
CAP
BOUCHON
PLUGUE

Ref.	Ø (mm)			€
7120	32	-	300	0,9900
7121	40	-	300	0,9900
7122	50	-	200	1,3000
7123	75	-	100	3,1000
7124	90	-	80	4,1000
7125	110	-	40	6,1000
7126	125	-	20	6,9000
7127	160	-	10	7,1000



MANGUITO HEMBRA-HEMBRA
SOCKET
MANCHON FEMELLE-FEMELLE À COLLER
MANGA FÊMEA-FÊMEA

Ref.	Ø (mm)			€
7100	32	-	300	0,9900
7101	40	-	300	0,9900
7102	50	-	200	1,300
7103	75	-	100	3,1000
7104	90	-	80	4,1000
7105	110	-	40	6,1000
7106	125	-	20	6,9000
7107	160	-	10	7,1000



CODO HEMBRA-HEMBRA 67° 30'
FEMALE-FEMALE ELBOW 67° 30'
COUDE FEMELLE-FEMELLE 67° 30'
COTOVELO FÊMEA-FÊMEA 67° 30'

Ref.	Ø (mm)			€
6920	32	-	300	1,6000
6921	40	-	300	1,6000
6922	50	-	200	1,9000
6925	110	-	40	16,0000

TE HEMBRA-HEMBRA 67° 30'
FEMALE-FEMALE TEE 67° 30'
TE FEMELLE-FEMELLE 67° 30'
TE FÊMEA-FÊMEA 67° 30'

Ref.	Ø (mm)			€
7020	32	-	250	1,8000
7021	40	-	300	1,8000
7022	50	-	100	2,9900
7025	110	-	20	9,9000



CODO MACHO-HEMBRA 45°
MALE-FEMALE ELBOW 45°
COUDE MÂLE-FEMELLE 45°
COTOVELO MACHO-FÊMEA 45°

Ref.	Ø (mm)			€
6900	32	-	300	1,0400
6901	40	-	300	1,0400
6902	50	-	200	2,4000
6903	75	-	70	2,9000
6904	90	-	50	2,9900
6905	110	-	50	3,9500
6906	125	-	40	4,4000
6907	160	-	20	8,3000



TE MACHO-HEMBRA 87° 30'
MALE-FEMALE TEE 87° 30'
TE MALE-FEMELLE 87° 30'
TE MACHO-FÊMEA 87° 30'

Ref.	Ø (mm)			€
7010	32	-	300	1,1000
7011	40	-	300	1,1000
7012	50	-	200	2,6000
7013	75	-	70	9,2000
7014	90	-	50	14,1000
7015	110	-	50	11,9000
7016	125	-	40	22,5000
7017	160	-	20	75,9000



REDUCCIÓN EXCÉNTRICA
HEMBRA-MACHO
FEMALE-MALE ECCENTRIC
REDUCER
RÉDUCTION EXCENTRÉE
FEMELLE-MÂLE
REDUÇÃO EXCÊNTRICA
MACHO-FÊMEA

Ref.	Ø (mm)			€
7114	90-75	-	80	3,5000
7115	110-90	-	40	5,5000
7116	125-110	-	20	6,5000
7117	160-125	-	10	12,0000



CODO MACHO-HEMBRA 87° 30'
MALE-FEMALE ELBOW 87° 30'
COUDE MÂLE-FEMELLE 87° 30'
COTOVELO MACHO-FÊMEA 87° 30'

Ref.	Ø (mm)			€
6930	32	-	300	1,0400
6931	40	-	300	1,0400
6932	50	-	200	2,4000
6933	75	-	70	2,9000
6934	90	-	50	2,9900
6935	110	-	50	3,9500
6936	125	-	40	4,4000
6937	160	-	20	8,3000



TE MACHO-HEMBRA 45°
MALE-FEMALE TEE 45°
TE MALE-FEMELLE 45°
TE MACHO-FÊMEA 45°

Ref.	Ø (mm)			€
7040	32	-	300	1,1000
7041	40	-	300	1,1000
7042	50	-	200	2,6000
7043	75	-	70	9,2000
7044	90	-	50	14,1000
7045	110	-	50	11,9000
7046	125	-	40	22,5000
7047	160	-	20	75,9000





**JUNTA LABIADA/TAPÓN/
JUNTA REGISTRO**

Ref.	Ø (" - mm)	€
6809	70	2,4417
6602	Peq. 36	0,3805
6603	Gra. 60	0,4406
6402	TAPON 46	1,40086



FITTING TUERCA

Ref.	Ø (" - mm)	€
4400	16	0,5932
4401	20	0,5932
4402	25	0,8900
4403	32	1,0828
4404	40	1,5426
4405	50	1,8986
4406	63	3,0566
4407	75	6,0813
4408	90	11,6880



FITTING PRISIONERO

Ref.	Ø (" - mm)	€
4500	16	0,4154
4501	20	0,4154
4502	25	0,4895
4503	32	0,5487
4504	40	0,5226
4505	50	0,6230
4506	63	0,6526
4507	75	0,6971
4508	90	0,7565



FITTING TUERCA

Ref.	Ø (" - mm)	€
4600	16	0,4531
4601	20	0,4531
4602	25	0,5340
4603	32	0,5664
4604	40	0,5987
4605	50	0,6796
4606	63	0,7119
4607	75	0,7605
4608	90	0,8253



FITTING JUNTA

Ref.	Ø (" - mm)	€
4700	16	0,4154
4701	20	0,4154
4702	25	0,4895
4703	32	0,5191
4704	40	0,5487
4705	50	0,6230
4706	63	0,6526
4707	75	0,6971
4708	90	0,7565



**VÁLVULA EXTENSIBLE
CON TAPÓN Y CADENA**

Ref.	Ø (" - mm)	U	C	€
6807	1 1/2-40-70	1	50	5,1247



**TE TUBOS LISOS
TOMA**

Ref.	Ø (" - mm)	U	C	€
6800	1 1/2 - 40	1	50	4,8593



**TE TUBOS LISOS
Y MACHO**

Ref.	Ø (" - mm)	U	C	€
6801	1 1/2 - 40	1	50	4,6059



**ENLACE MACHO
PVC**

Ref.	Ø (" - mm)	U	C	€
6802	1 1/2 - 40	1	50	1,9080

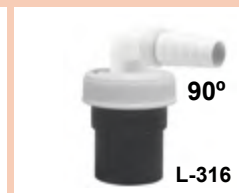

**ENLACE MACHO PVC
TOMA ELECT.**

Ref.	Ø (" - mm)	U	C	€
6817	1 1/2 - 40	1	50	4,2281



CODO PARA TUBOS LISOS

Ref.	Ø (" - mm)	U	C	€
6804	1 1/2 - 40	1	50	3,0408



**CODO PARA TUBO LISO Y
HEMBRA**

Ref.	Ø (" - mm)	U	C	€
6805	1 1/2 - 40	1	50	2,6546

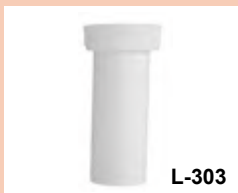

**ALARGADERA EXTENS. CON
TUERCA**

Ref.	Ø (" - mm)	U	C	€
6806	1 1/2 - 40	1	50	2,0016



**MANGUITO PARA TUBOS
LISOS**

Ref.	Ø (" - mm)	U	C	€
6808	1 1/2 - 40	1	50	1,7428



**CONJUNTO PARA VÁLVULA
C/ TAPÓN Y CADENA**

Ref.	Ø (" - mm)	U	C	€
6811	1 1/2-40-70	1	50	4,6804



JUNTA CÓNICA

Ref.	Ø (" - mm)	€
6509	1	0,3171
6600	1 1/2	0,3673



TUERCA SANITARIO

Ref.	Ø (" - mm)	€
6400	1	0,3840
6401	1 1/2	0,4174



PLAFÓN

Ref.	Ø (" - mm)	€
6814	40	0,6558
6815	40	1,3117



TOMA ELECTR. 90°

Ref.	Ø (" - mm)	U	C	€
6812	1	1	50	2,5191
6813	1 1/2	1	50	2,5191



TAPÓN Y CADENA

Ref.	Ø (" - mm)	€
6403	270	4,7505
6404	380	7,3798



JUNTA ESTANQUEIDAD

Ref.	Ø (" - mm)	€
6504	70	0,4769
6505	85	0,5110
6601	1 1/2- 1 1/4	0,4383



JUNTA BASE CAZOLETA

Ref.	Ø (" - mm)	€
6506	70	0,3130
6507	85	0,3681
6508	115	0,4558



CADENA / REBOSADERO

Ref.	Ø (" - mm)	€
6502	270	1,8932
6503	380	2,7521
6408	80	1,8932



TORNILLO INOX



Ref.	Ø (" - mm)	€
6409	70	0,7826
6500	45	0,5438
6501	35	0,4909



CAZOLETA INOX

Ref.	Ø (" - mm)	€
6405	70	1,6302
6406	85	1,7353
6407	115	1,8932



Tipo de caja Type of boxes	REF	Dimensiones (mm) / largo x ancho x alto Size (mm) / length x width x high	Volumen (m3) Volume (m3)	Tipo de caja Type of boxes	REF	Dimensiones (mm) / largo x ancho x alto Size (mm) / length x width x high	Volumen (m3) Volume (m3)
	A5	300 x 200 x 150	0,0090		A3	600 x 400 x 335	0,0804
	A1	400 x 200 x 220	0,0176		A7	600 x 400 x 400	0,0960
	A2	400 x 200 x 440	0,0352		A8	400 x 200 x 500	0,0400
	A4	400 x 400 x 350	0,0560				

CONDICIONES GENERALES DE VENTA

- El suministro de materiales, objeto del pedido, se hará conforme a las condiciones generales que se detallan a continuación, las cuales se consideran aceptadas por el cliente una vez realizado el pedido.
- La factura de los distintos materiales, se realizará de acuerdo con los precios de la tarifa vigente en el momento del suministro.
- Las operaciones de compraventa, sea cual sea el lugar de entrega de la mercancía, se entienden realizadas en el domicilio social de ABANILLA RIEGOS, S.A. por lo tanto ambas partes aceptan la competencia de los Juzgados y Tribunales de Alicante, con renuncia a su propio fuero y domicilio.
- Todos nuestros artículos son garantizados por un año de fecha factura, o entrega, de todo defecto de fabricación. Esta garantía queda limitada única y exclusivamente a la sustitución del material que sea considerado como defectuoso, una vez revisado por nuestro técnico de ABANILLA RIEGOS, S.A. teniendo en cuenta que no se admitirán devoluciones ni reclamaciones de material transcurridos 8 días de su recepción, en caso de acuerdo dentro de este plazo, el material deberá ser remitido perfectamente embalado y dirigido a portes pagados a nuestros almacenes.
- ABANILLA RIEGOS, S.A. se reserva los derechos sin previo aviso de modificar medidas, diseño y variación, composición de materiales, siempre encaminado a la mejora de nuestro producto, a lo que también puede variar las tarifas de precios.
- Esta tarifa anula las anteriores. Precios válidos salvo error tipográfico.

GENERAL SALE CONDITIONS

- The delivery of the material, object of an order, will be done according to the general conditions that are explained below. Once the client makes and order, it is understood that he/she has accepted these conditions.
- The invoice for different materials will be send out according to the current price list and normally attached to their supply.
- The buying and selling deals, no matter what the delivery destination is, are understood to be done in ABANILLA RIEGOS, S.A. registered address, thus both parts accept the court of Alicante competence, renoucing to their own privilege and address.
- All our accessories are guaranteed for one year counting from the date printed on the invoice, or delivery, for all manufactured faulties. This guarantee is only limited to the replacement of the material that is considered faulty, once it has been checked by our ABANILLA RIEGOS, S.A. technician. Please, bear in mind that material returns and claims will not be accepted after 8 days of the check in. In case of agreement within this term, this material must be sent to our store fully packed and free of any charge of transport.
- ABANILLA RIEGOS, S.A. reserves its right to modify measures, design and variation, raw material composition without warning, always aimed to improve our product, to which a change of prices can be also applied.
- This price list cancel previous ones.



ABANILLA RIEGOS S.A.
C/ Camino de Borja, 29--31.
(Continuación Avda. Zodiaco)
03006 Alicante (España)
Apdo. Correos 5051-03080
Tlf: +34 965 104 874
abrisa@riegos.com

www.riegos.com

